



HAPPY STRUCTURES





MORE THAN SLIDES

These are not your average playground slides. Designed by Bananaz Studio and built by OSOM, our playslides are bold, sculptural structures that invite climbing, crawling, socializing, and, of course, sliding.

Each one is a multi-sensory experience — with play features above, below, and all around — made to spark curiosity and movement at every level. Whether in a public park or an urban square, they turn any space into a mini adventure.

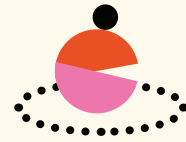

COMPACT DESIGN

Compact footprint, maximum fun, smartly designed to fit under 65 sqm. These all-in-one units deliver climbing, sliding, sensory, and social play.



ACTIVE PLAY

Play that builds skills such as physical strength, balance, and focus through varied climbing routes and active play challenges. Engaging top platforms at 1.5 m and 2 m heights.



SENSORY PLAY

Multi-sensory and inclusive, featuring tactile panels, color filters, rotating windows, and rope elements. Designed to engage children of diverse abilities.

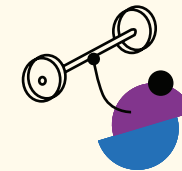

BUILT TO LAST

Durable and customizable, made from high-quality materials to ensure long-lasting appeal and design flexibility.



SOCIAL INTERACTION

Promotes collaboration and connection as children explore, play, and invent games together.



SCULPTURAL AESTHETIC

Bold, artistic designs that double as landmarks, adding character and beauty to any space.

ELMA



MORA



BERRY

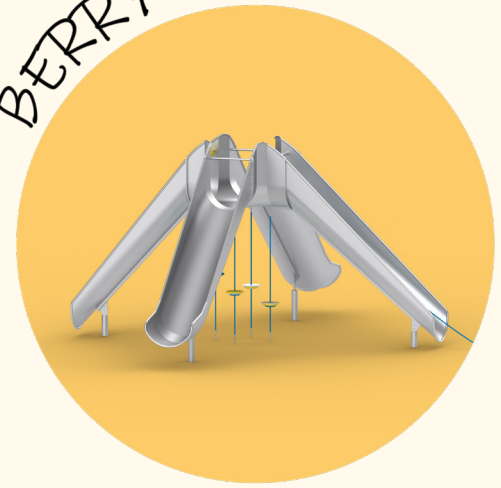

MOMO



MALINA



MIRABELLE

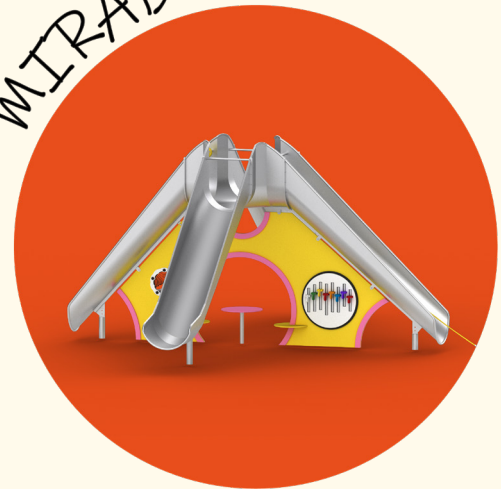

ELMA



ELMA

Toddlers adventure slide

Platform height 1.50m

ELMA is specially designed for the youngest adventurers. Standing at 1.50 meters, it offers a safe and exciting introduction to sliding. Easy climbing routes lead to the top, while a cozy play area underneath invites toddlers to explore, discover, and socialize.

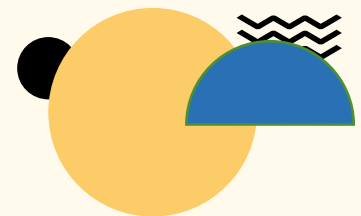

ELMA

Toddlers adventure slide

Highlights:

- Slides
- Climbing Nets & Grips
- Windows & Rotating Plates
- Abacus Plates

Product Information:

Dimension L x W x H	4.50m x 4.60m x 2.50m
Age group:	2 - 6 years
Max falling height:	1.50m

Play activities:

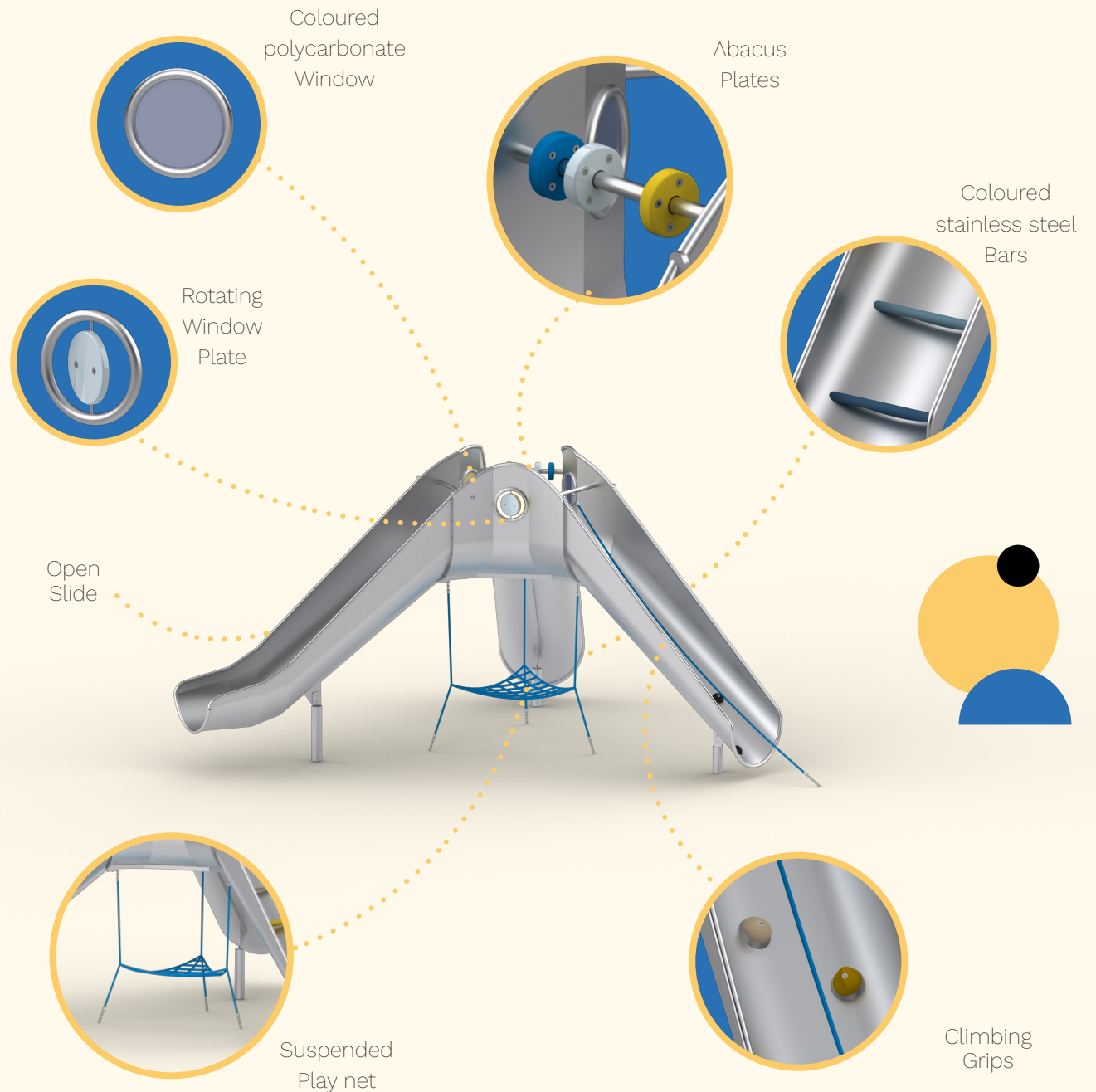

ELMA

Toddlers adventure slide

Colour options available for:

Main Slide Structure:	✓
Suspended Play Net:	✓
Climbing Grips:	✓
Coloured Windows:	✓
Rotating Window:	✓
Abacus Plates:	✓

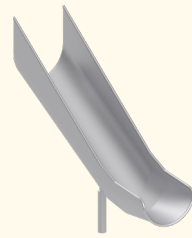

Open Slide

A stainless steel slide starting from 1,5 m high offers an exciting descent that builds balance, spatial awareness, and core strength. Taking turns promotes patience and social awareness.

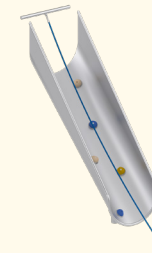

Access Route with Grips & Rope

Equipped with climbing grips and reinforced rope, this access route develops strength, coordination, and problem-solving. Kids learn to navigate vertical movement while taking turns and supporting one another.

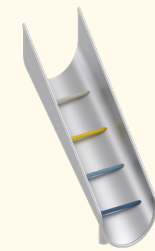

Access Route with Steel Bars

Colorful stainless steel bars challenge children's balance, focus, and body control. The open design encourages anticipation and interaction, adding a social element to physical play.

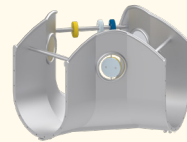

Top Platform

This transition space connects climbing and sliding. Children pause here to observe, plan, and interact with others. It supports social play and decision-making before continuing the activity flow.

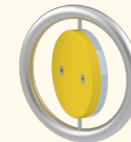

Rotating window

A circular HDPE panel that opens and closes like a window, perfect for imaginative scenarios. It helps children understand visibility, surprise, and simple mechanics.



Coloured Window

Transparent polycarbonate panels in bright colors shift children's visual perspective. Looking through them inspires wonder, imaginative play, and shared discoveries.

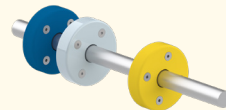

Abacus Play

HDPE spinning panels on a horizontal bar allow kids to explore motion and patterns. The tactile experience supports motor skills and encourages collaborative or parallel play.

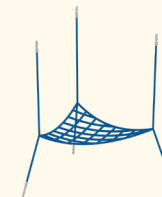

Suspended Play Net

This rope net forms a flexible base for resting, wobbling, or gentle play. It offers a relaxing, slightly active area for social interaction and balance training.

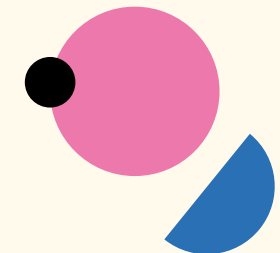

ELMA

Toddlers adventure slide

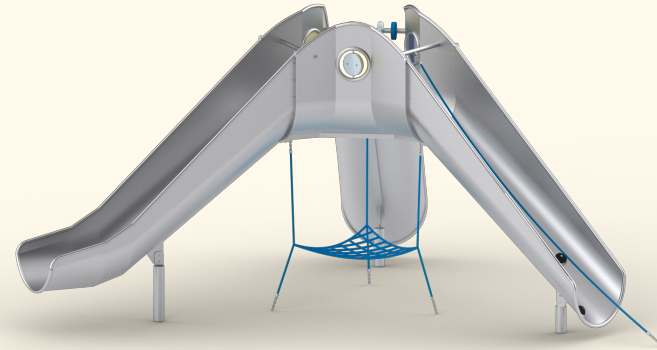
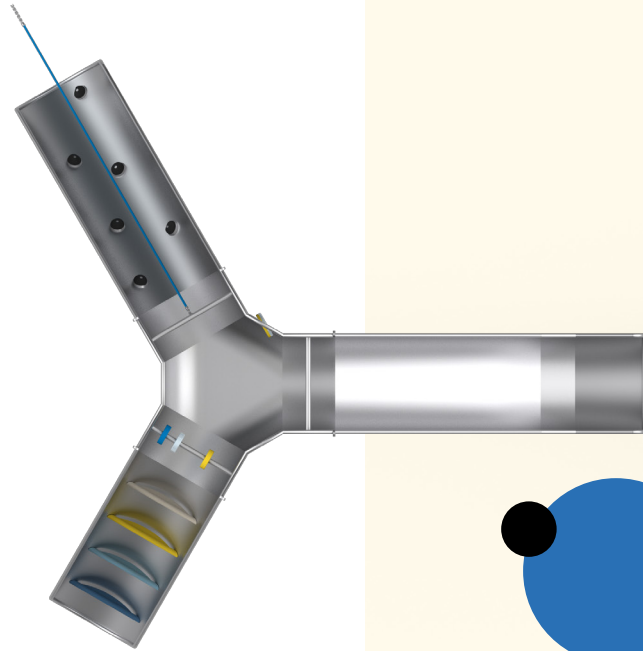

3.00m

2.00m

1.00m

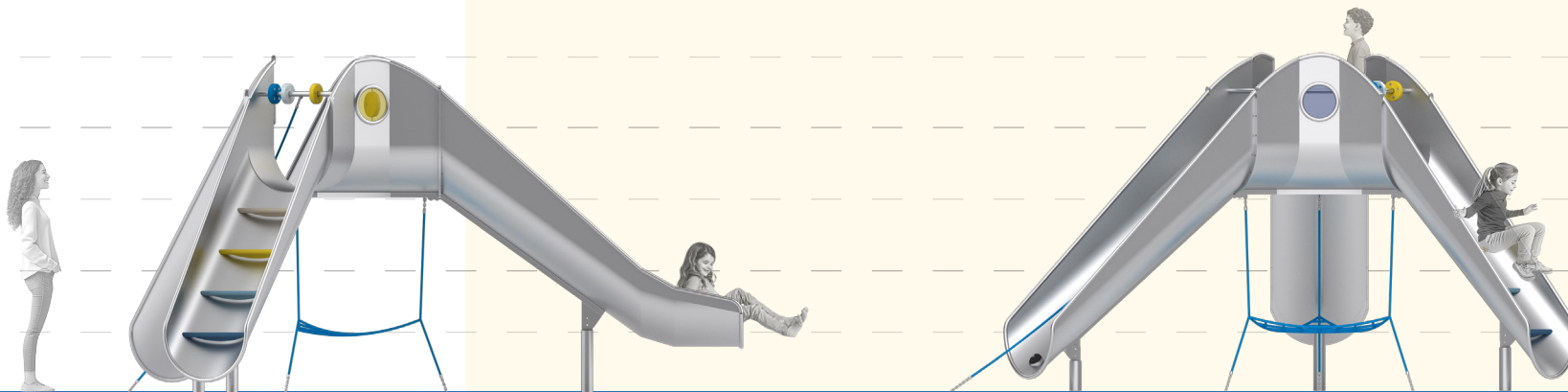

ELMA

Toddlers adventure slide

Installation information:

Safety zone surfacing area: 7.55m x 7.75m

Concrete volume: 0.57 m³

Footing depth: 80cm/50cm

Shipment weight: 430 kg

Shipment box size: 6x2,2x1,3m

Lead time: 6 weeks

Warranty stainless steel parts: 36 months

Warranty other parts: 24 months

Anchoring options:

-Surface mount Installation: -10cm

-Inground Installation: -40cm

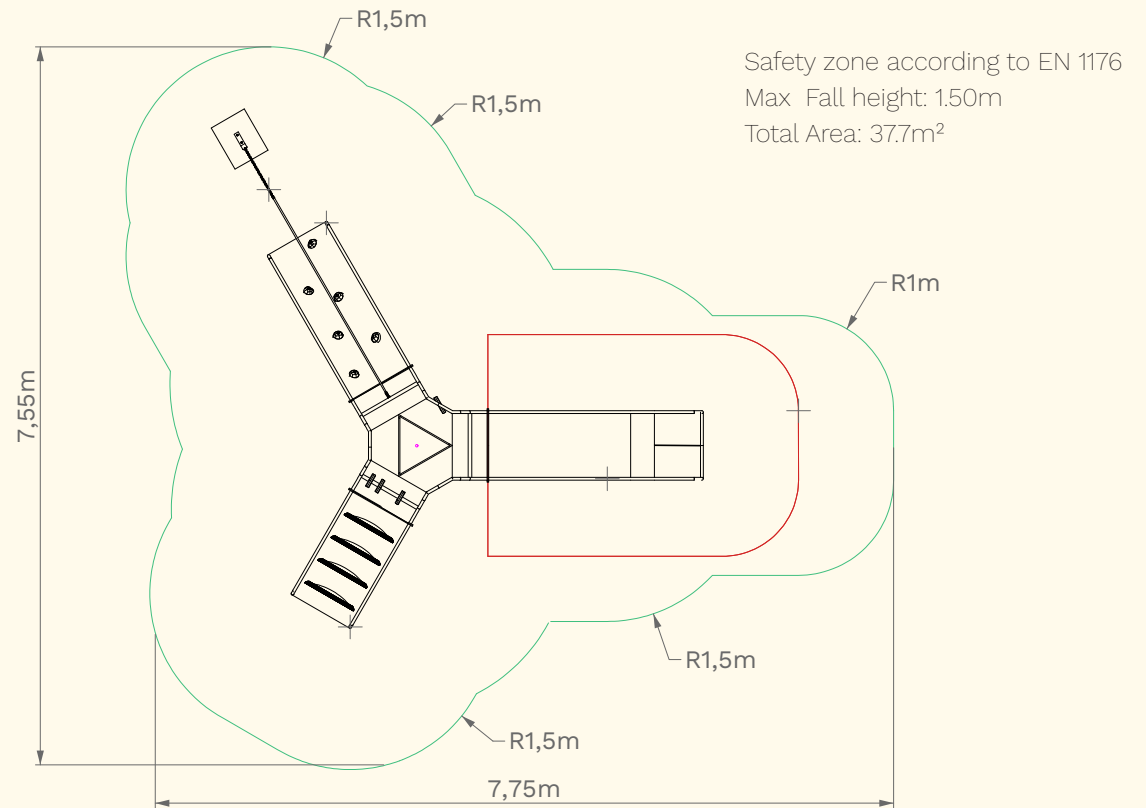

Anchoring options:

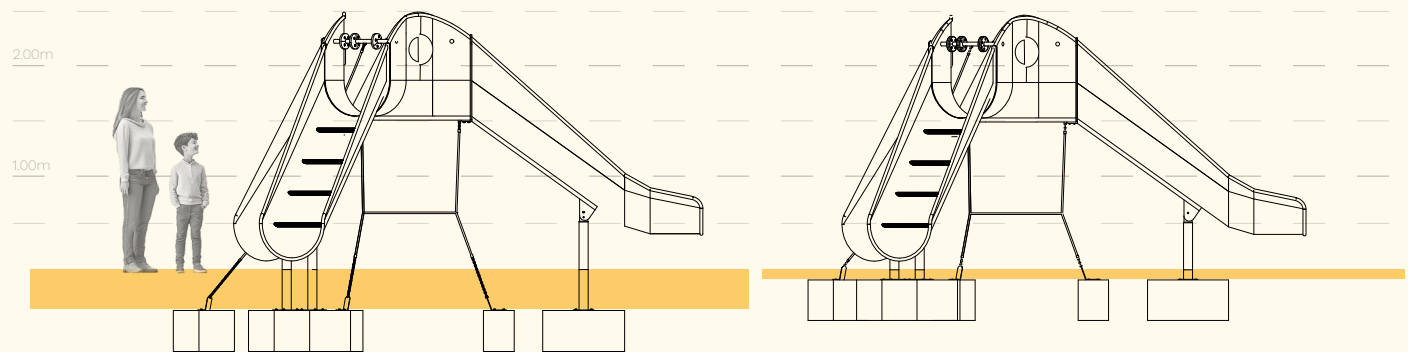

Inground Installation -40cm

Surface mount Installation -10cm



MOMO



MOMO

Toddlers adventure slide

Platform height 1.50m

MOMO redefines what a slide can be. With a 1,5-meter platform height, it's not just a slide - it's a dynamic playground in itself. Ground-level panels feature sound elements and interactive play items, while multiple climbing routes offer a fun challenge. The entire structure encourages kids to climb, explore, connect, and then slide. Each step sparking the next adventure.

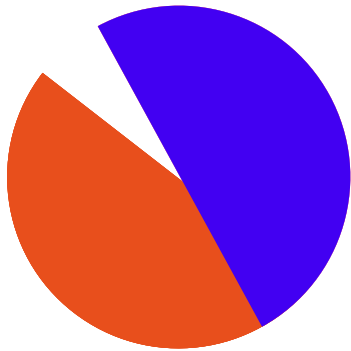

MOMO

Toddlers adventure slide

Highlights:

- Slide
- Climbing Nets & Grips
- Windows & Rotating Plates
- Abacus Plates
- Sound Panels
- Optical Illusion Panels

Product Information:

Dimension L x W x H	4.50m x 4.60m x 2.50m
Age group:	2-6 years
Max falling height:	1.50m

Play activities:

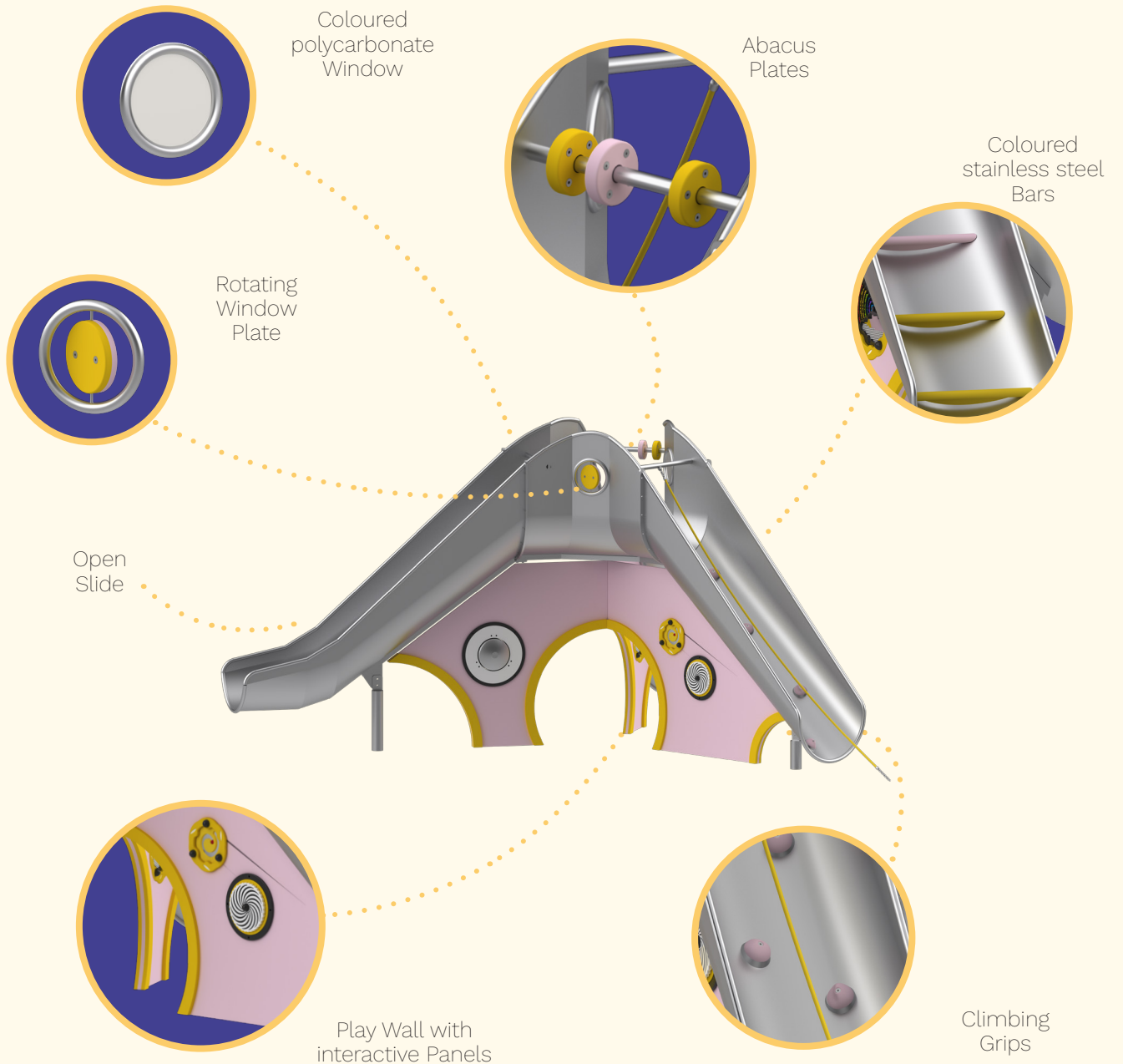
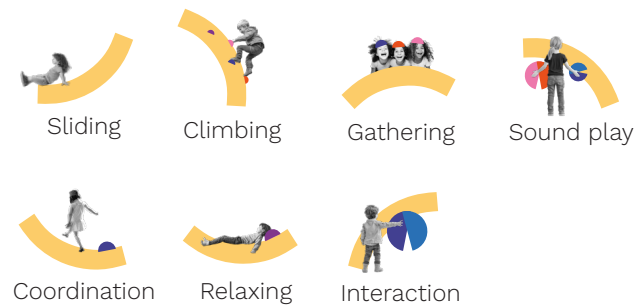

MOMO

Toddlers adventure slide

Colour options available for:

Main Slide Structure:	✓
Climbing Grips:	✓
Coloured Windows:	✓
Rotating Window:	✓
Abacus Plates:	✓
Play wall with panels	✓

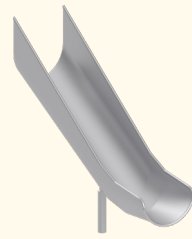

Open Slide

A stainless steel slide starting from 2 m high offers an exciting descent that builds balance, spatial awareness, and core strength. Taking turns promotes patience and social awareness.

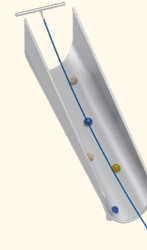

Access Route with Grips & Rope

Equipped with climbing grips and reinforced rope, this access route develops strength, coordination, and problem-solving. Kids learn to navigate vertical movement while taking turns and supporting one another.

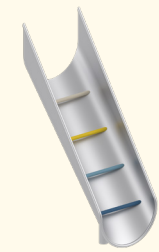

Access Route with Steel Bars

Colorful stainless steel bars challenge children's balance, focus, and body control. The open design encourages anticipation and interaction, adding a social element to physical play.

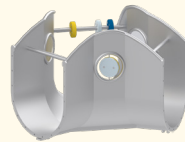

Top Platform

This transition space connects climbing and sliding. Children pause here to observe, plan, and interact with others. It supports social play and decision-making before continuing the activity flow.

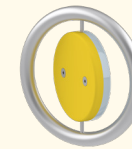

Rotating window

A circular HDPE panel that opens and closes like a window, perfect for imaginative scenarios. It helps children understand visibility, surprise, and simple mechanics.



Coloured Window

Transparent polycarbonate panels in bright colors shift children's visual perspective. Looking through them inspires wonder, imaginative play, and shared discoveries.

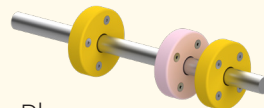

Abacus Play

HDPE spinning panels on a horizontal bar allow kids to explore motion and patterns. The tactile experience supports motor skills and encourages collaborative or parallel play.

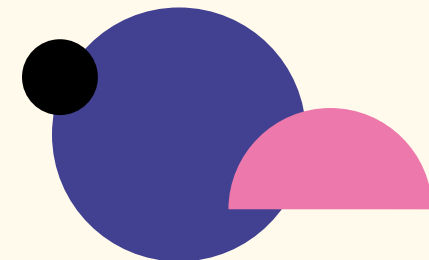

MOMO

Toddlers adventure slide

Colour options available for:

- Mini Spinning Optical Illusion Insert: ✓
- Mini Shaker Insert: ✓
- Rainbow Insert: ✓
- Wormhole Optical Illusion Insert: ✓
- Tongue Drum Musical Insert: ✓



Mini Spinning Spiral Optical Illusion Insert

Fun and engaging optical illusion which demonstrates how the brain can be tricked.



Mini Shaker Insert

Turn the insert to see and hear hundreds of tiny balls tumble around.

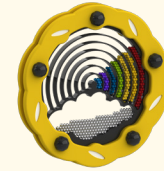

Rainbow Insert

Rotate the drum and watch the coloured balls move around the rainbow.



Wormhole Optical Illusion Insert

Rotate to see swirling patterns as this mind-bending optical illusion comes to life.

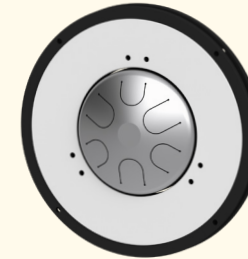

Tongue Drum Musical Insert

Superb oriental sounding stainless steel musical tongue drum played by hand.



View of panel 1 front and back

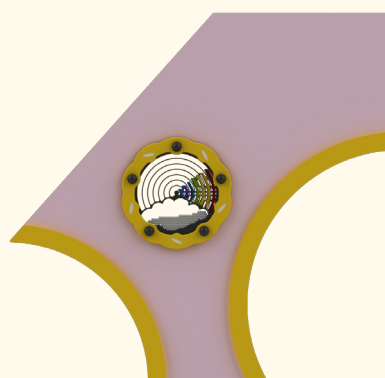
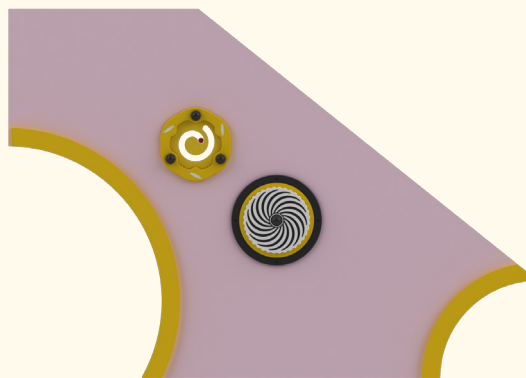

View of panel 2

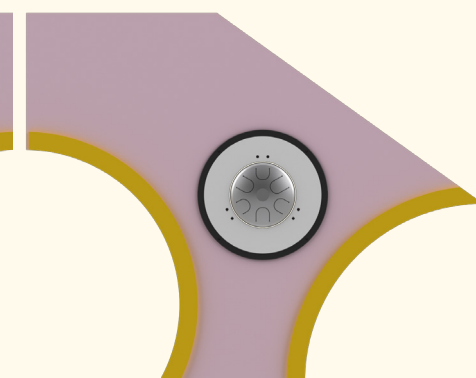

View of panel 3

Objects and data subject to modification.



MOMO

Toddlers adventure slide

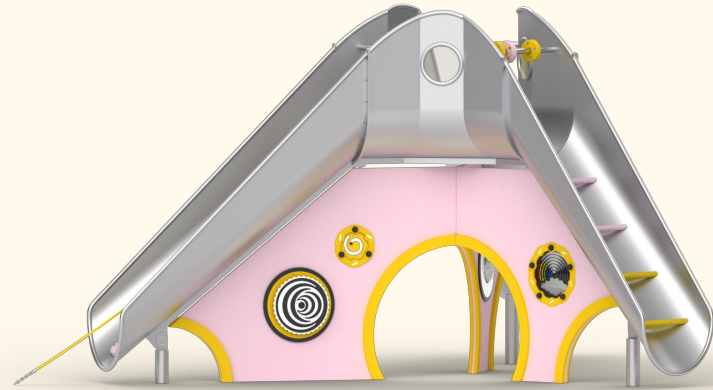
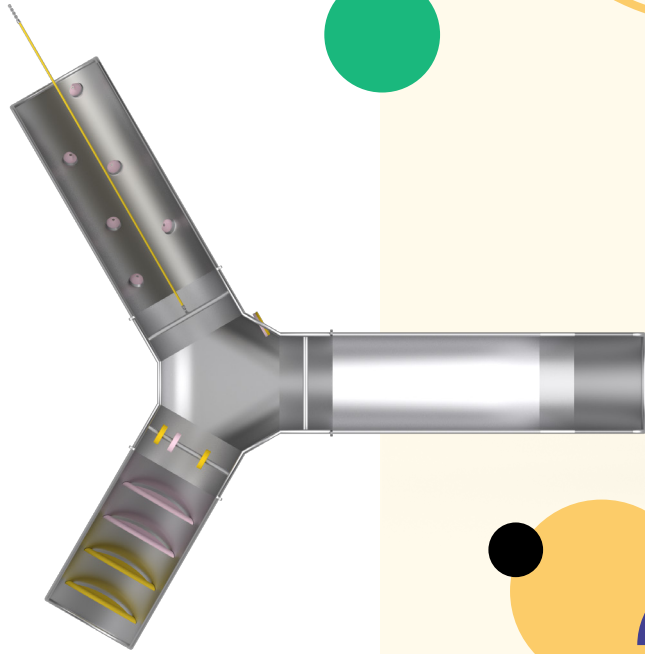

3.00m

2.00m

1.00m

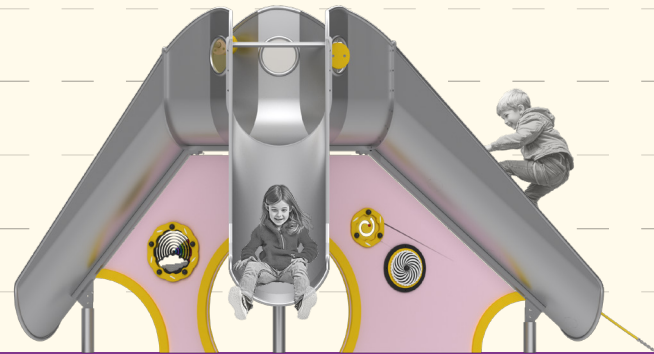
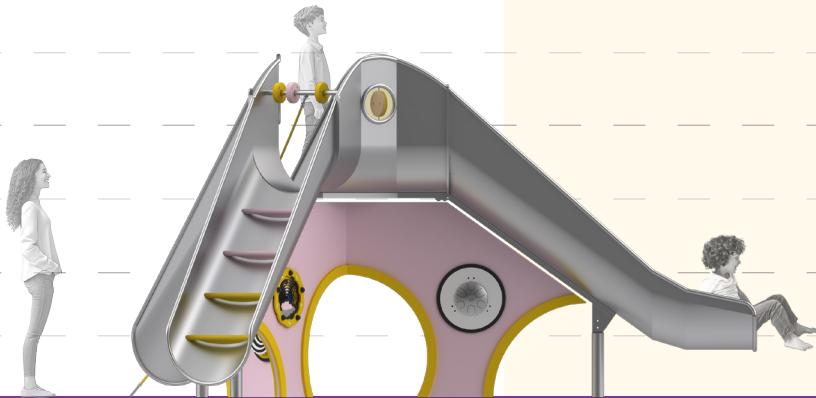

MOMO

Toddlers adventure slide

Installation information:

Safety zone surfacing area: 7.75m x 7.55m

Concrete volume: 0.57 m³

Footing depth: 80cm/50cm

Shipment weight: 540 kg

Shipment box size: 6x2,2x1,3m

Lead time 6 weeks

Warranty stainless steel parts 36 months

Warranty other parts 24 months

Anchoring options:

-Surface mount Installation -10cm

-Inground Installation -40cm

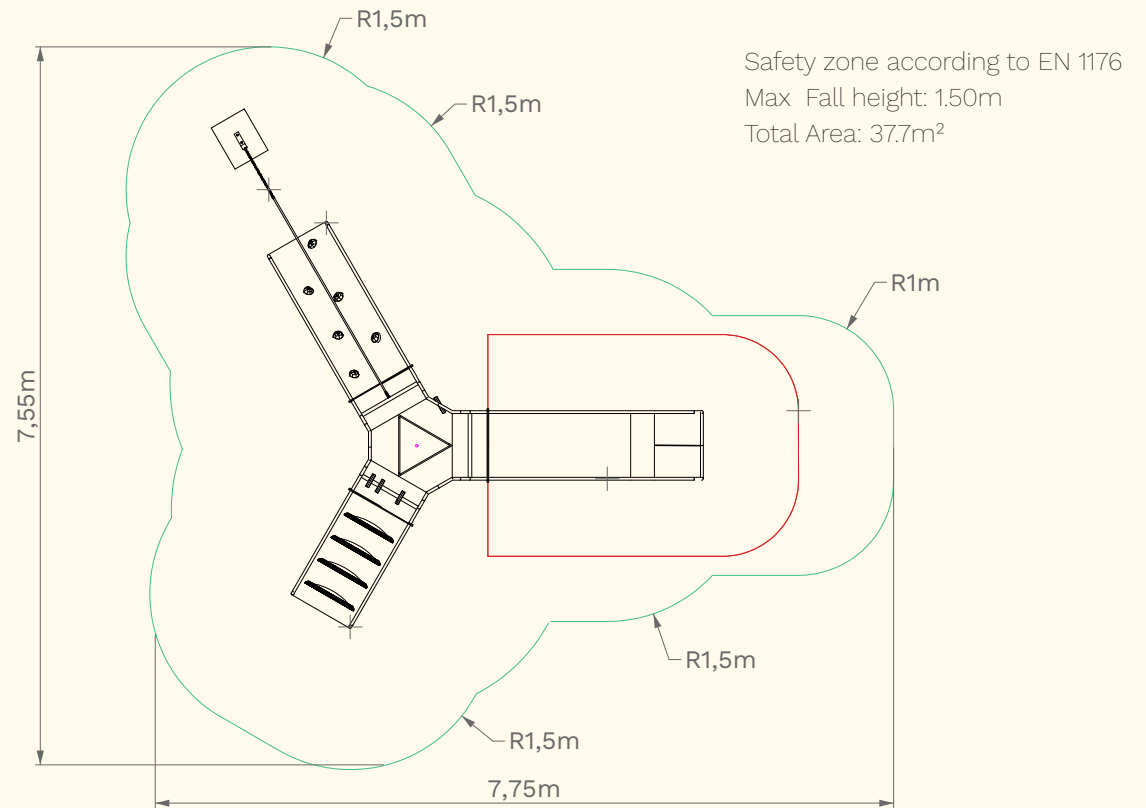

Anchoring options:

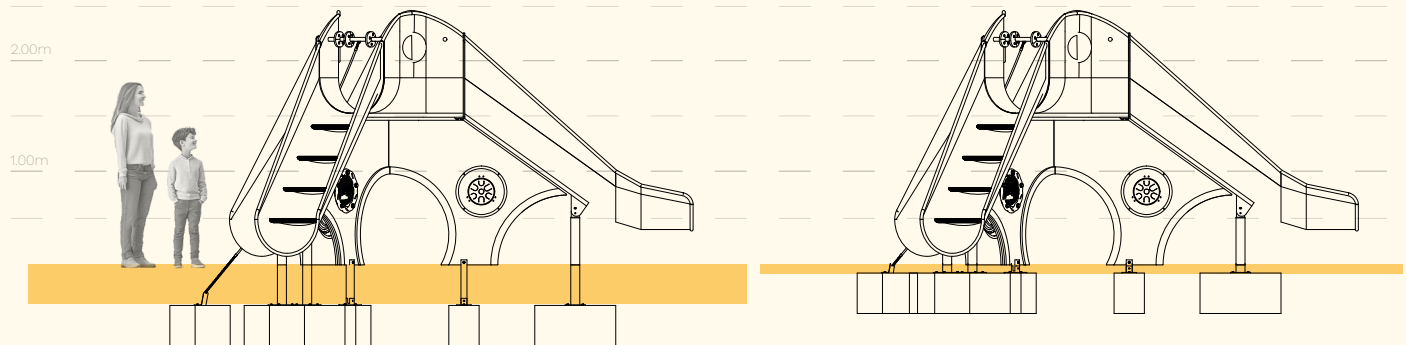

Inground Installation -40cm

Surface mount Installation -10cm



MORA

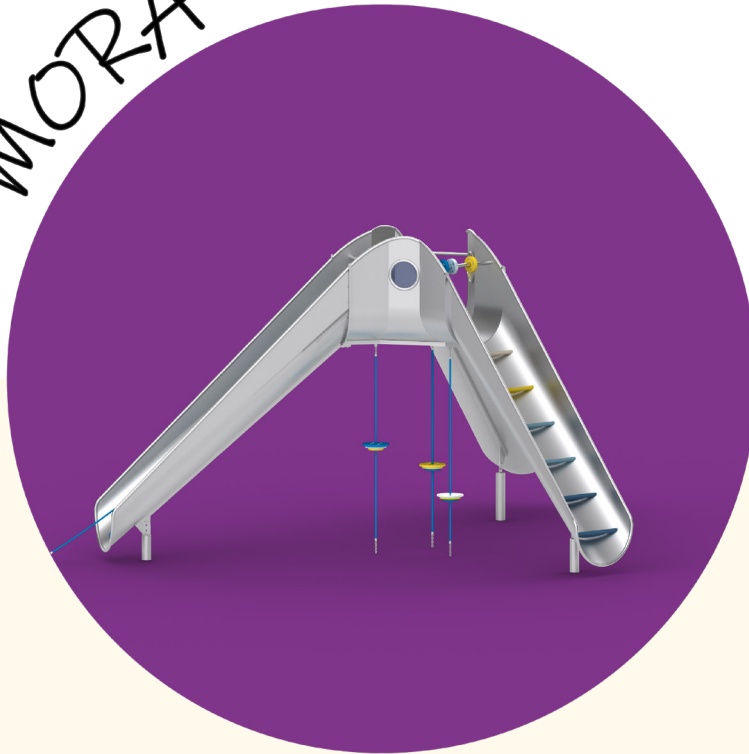

MORA

3 legs, 2m platform height

MORA is a minimalist's dream. Simple, sleek lines meet playful design in a slide that's both an art piece and a ride. Its sculptural form fits perfectly in any urban setting, bringing style and excitement to the heart of the playground.



MORA

3 legs, 2m platform height

Highlights:

- Slide
- Climbing Rope & Grips
- Windows & Rotating Plates
- Abacus Plates
- Set of Liana Ropes with Discs

Product Information:

Dimension L x W x H 5.5m x 5.5m x 3m

Age group: 3-99 years

Max falling height: 2.00m

Play activities:

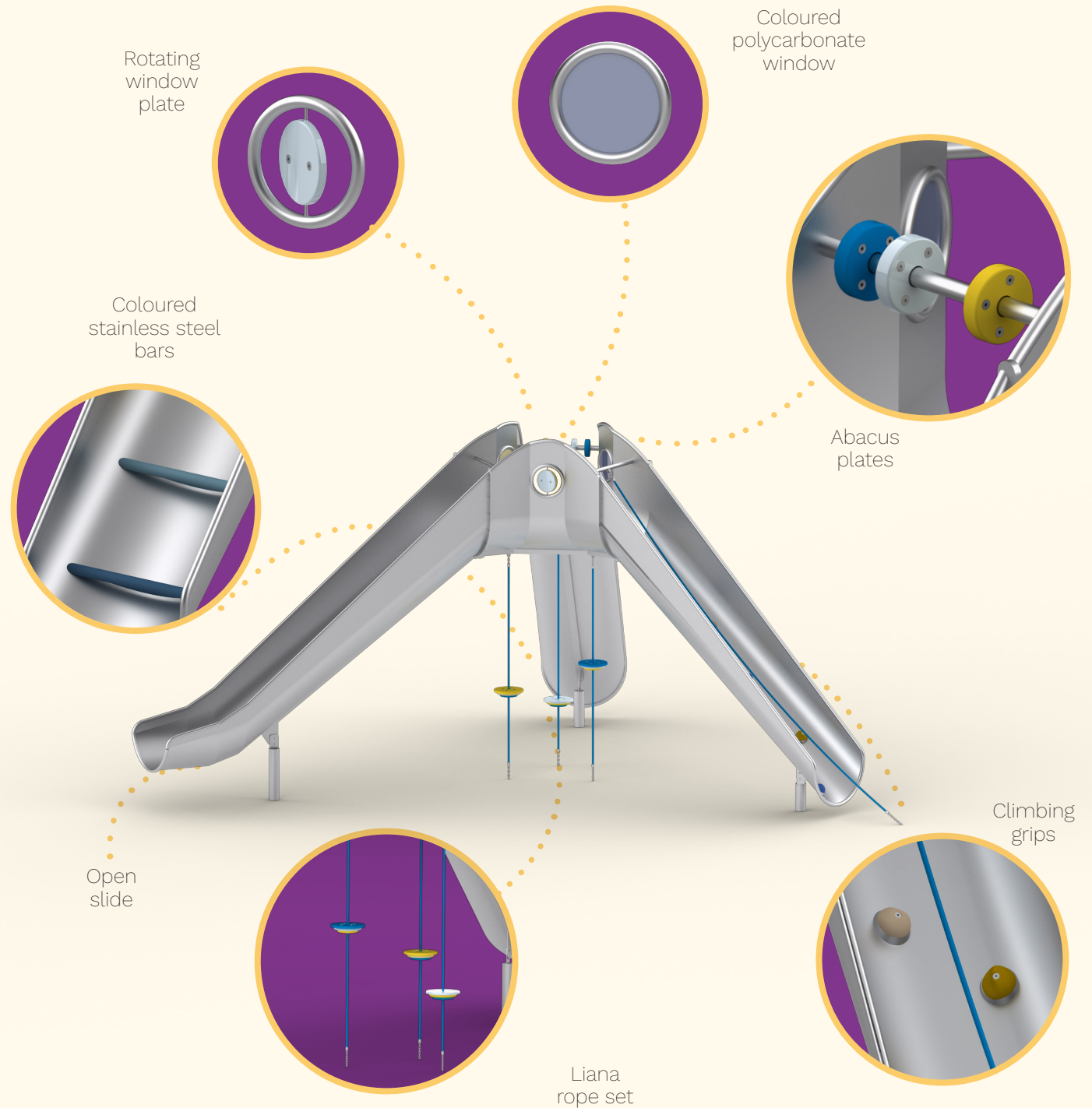
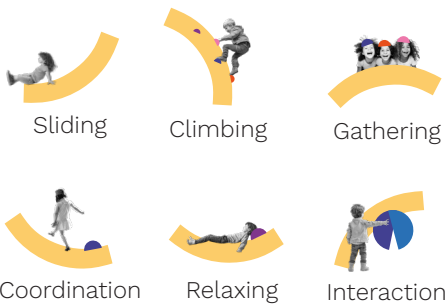

Objects and data subject to modification.

MORA

3 legs, 2m platform height

Colour options available for:

Main Slide Structure:	✓
Climbing Grips:	✓
Coloured Windows:	✓
Rotating Window:	✓
Abacus Plates:	✓
Liana Rope Set:	✓

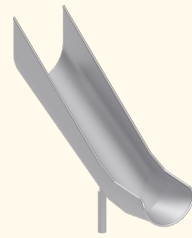

Open Slide

A stainless steel slide starting from 2 m high offers an exciting descent that builds balance, spatial awareness, and core strength. Taking turns promotes patience and social awareness.

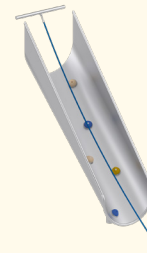

Access Route with Grips & Rope

Equipped with climbing grips and reinforced rope, this access route develops strength, coordination, and problem-solving. Kids learn to navigate vertical movement while taking turns and supporting one another.

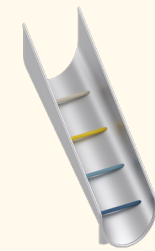

Access Route with Steel Bars

Colorful stainless steel bars challenge children's balance, focus, and body control. The open design encourages anticipation and interaction, adding a social element to physical play.

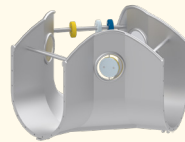

Top platform

This transition space connects climbing and sliding. Children pause here to observe, plan, and interact with others. It supports social play and decision-making before continuing the activity flow.

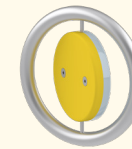

Rotating window

A circular HDPE panel that opens and closes like a window, perfect for imaginative scenarios. It helps children understand visibility, surprise, and simple mechanics.

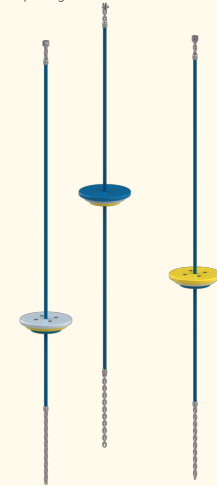

Liana ropes set

Three sturdy ropes suspend a round HDPE disc beneath the slide platform, creating a playful spot to sit, sway, or gather with friends. Balancing on the seat develops core strength, coordination, and spatial awareness.

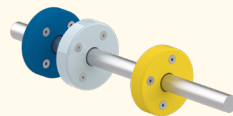

Abacus Play

HDPE spinning panels on a horizontal bar allow kids to explore motion and patterns. The tactile experience supports motor skills and encourages collaborative or parallel play.



Coloured Window

Transparent polycarbonate panels in bright colors shift children's visual perspective. Looking through them inspires wonder, imaginative play, and shared discoveries.



MORA

3 legs, 2m platform height

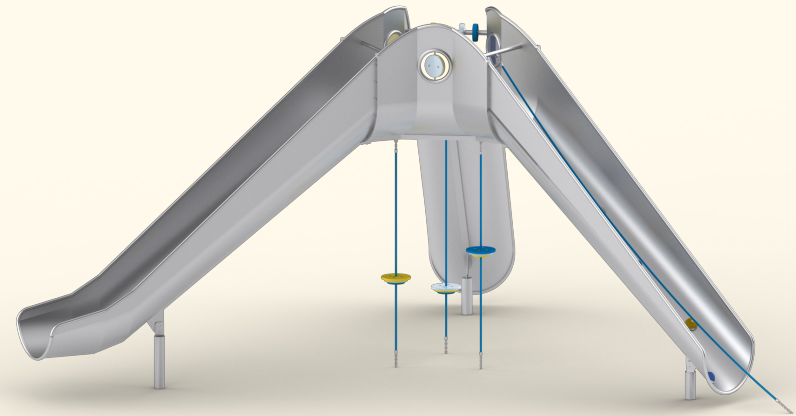
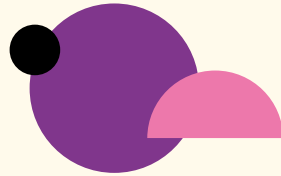
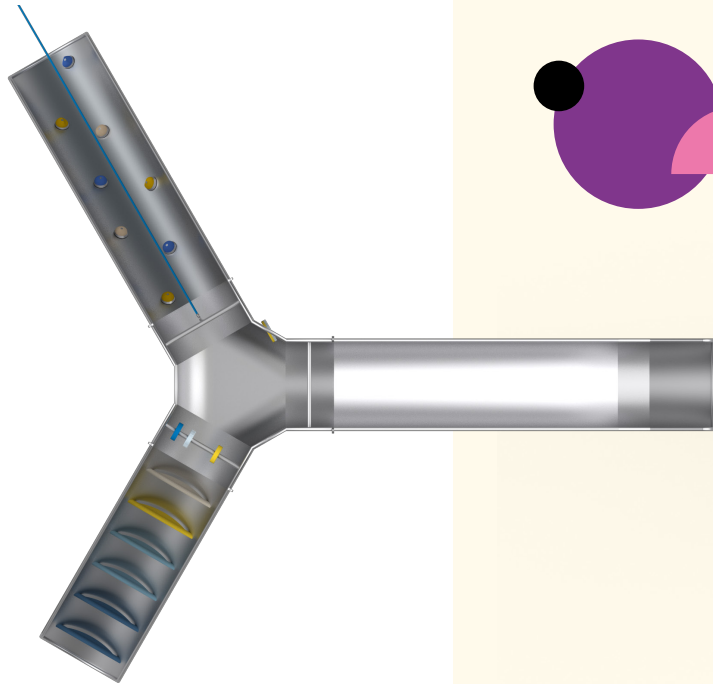

3.00m

2.00m

1.00m

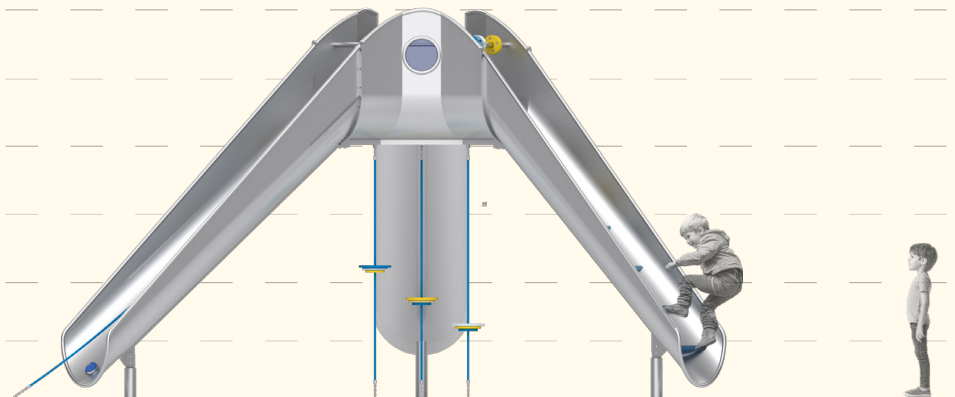
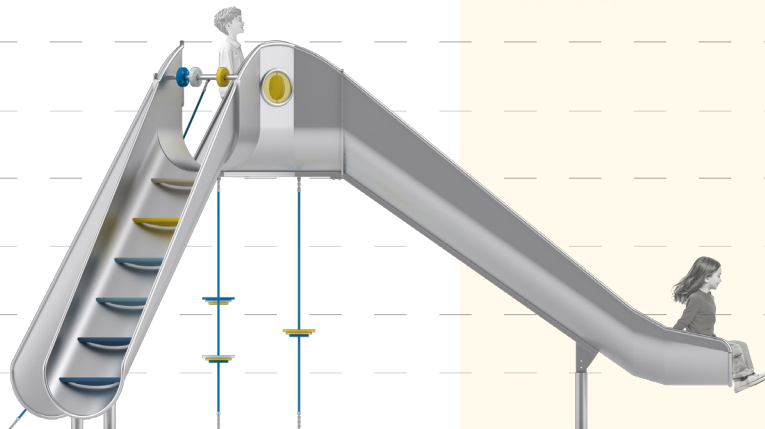

MORA

3 legs, 2m platform height

Installation information

Safety zone surfacing area: 8.5m x 9.1m

Concrete volume: 0,57 m³

Footing depth: 80cm/50cm

Shipment weight: 550kg

Shipment box size: 6.0 x 2.2 x 1.3m

Lead time: 6 weeks

Warranty stainless steel parts: 36 months

Warranty other parts: 24 months

Anchoring options:

-Surface mount Installation: -10cm

-Inground Installation: -40cm

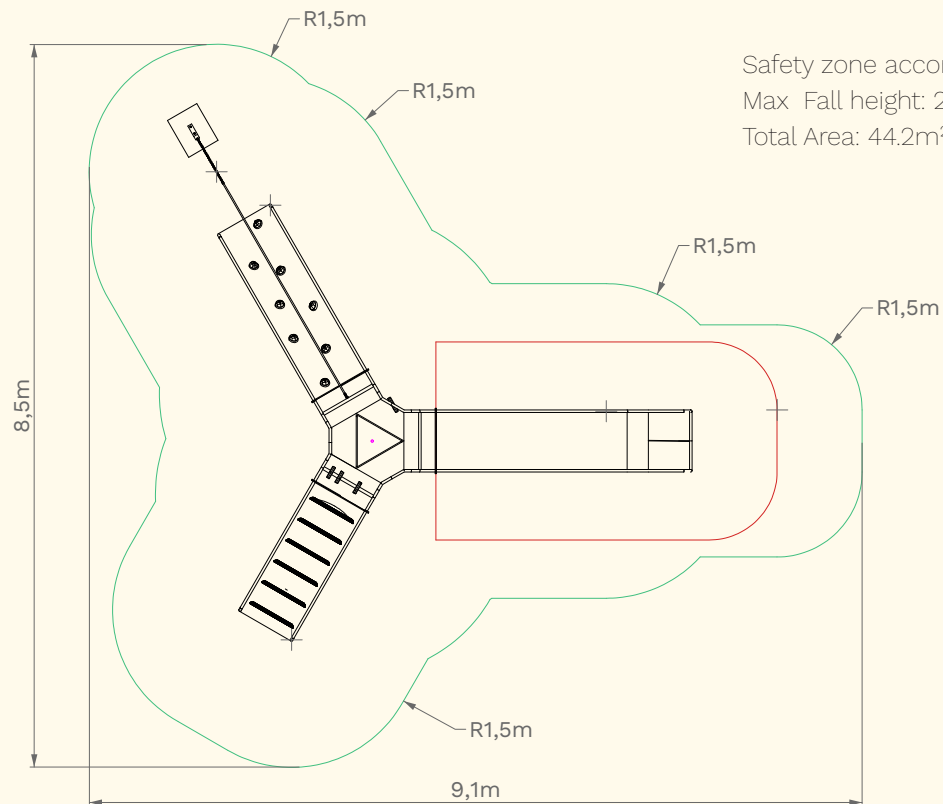

Anchoring options:

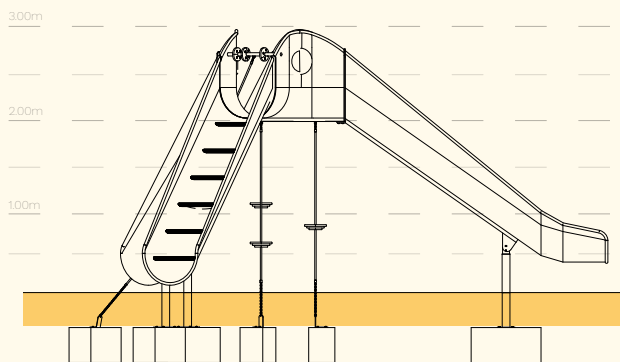

Inground Installation -40cm

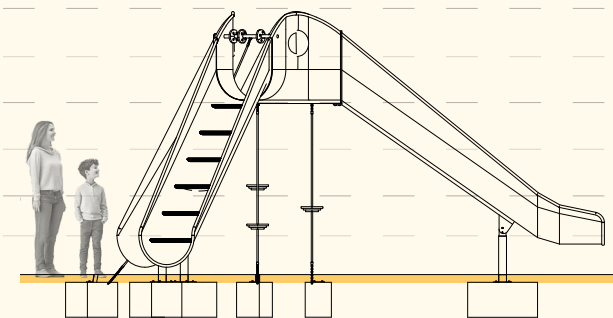

Surface mount Installation -10cm



MALINA



MALINA

3 legs, 2m platform height

MALINA redefines what a slide can be. With a 2-meter platform height, it's not just a slide - it's a dynamic playground in itself. Ground-level panels feature sound elements and interactive play items, while multiple climbing routes offer a fun challenge. At the heart of the structure is a central gathering table - an inviting spot for social play, creativity, or a moment of rest. The entire structure encourages kids to climb, explore, connect, and then slide. Each step sparking the next adventure.

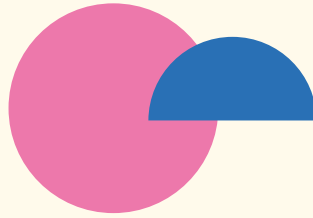

MALINA

3 legs, 2m platform height

Highlights:

- Slide
- Climbing Rope & Grips
- Windows & Rotating Plates
- Abacus Plates
- Sound Panels
- Optical Illusion Panels
- Gathering Table

Product Information:

Dimension L x W x H	5.5m x 5.5m x 3m
Age group:	3-99 years
Max falling height:	2.00m

Play activities:

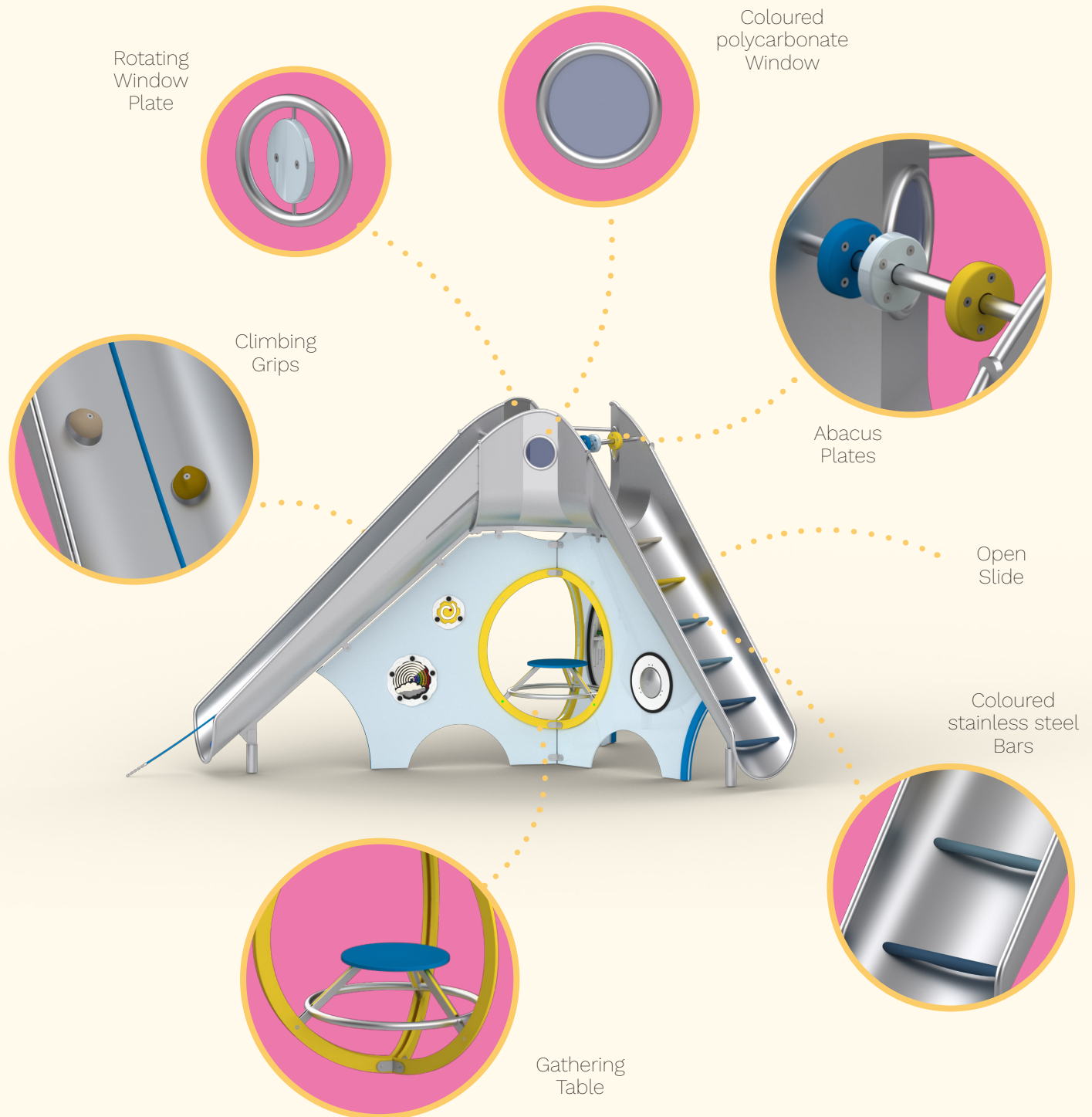
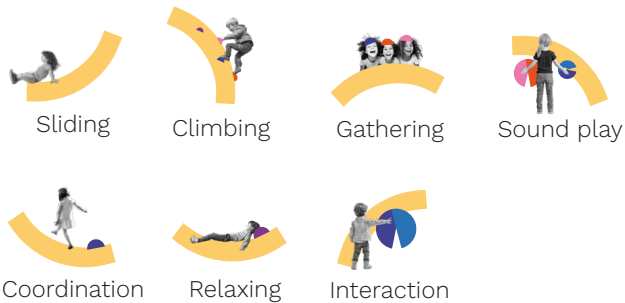

MALINA

3 legs, 2m platform height

Colour options available for:

Main slide structure:	✓
Climbing Grips:	✓
Coloured Windows:	✓
Rotating Window:	✓
Abacus Plates:	✓

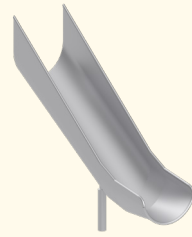

Open Slide

A stainless steel slide starting from 2 m high offers an exciting descent that builds balance, spatial awareness, and core strength. Taking turns promotes patience and social awareness.

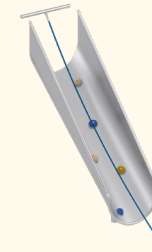

Access Route with Grips & Rope

Equipped with climbing grips and reinforced rope, this access route develops strength, coordination, and problem-solving. Kids learn to navigate vertical movement while taking turns and supporting one another.

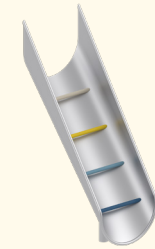

Access Route with Steel Bars

Colorful stainless steel bars challenge children's balance, focus, and body control. The open design encourages anticipation and interaction, adding a social element to physical play.

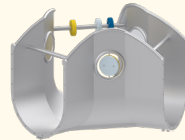

Top Platform

This transition space connects climbing and sliding. Children pause here to observe, plan, and interact with others. It supports social play and decision-making before continuing the activity flow.

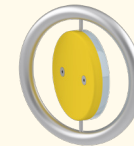

Rotating window

A circular HDPE panel that opens and closes like a window, perfect for imaginative scenarios. It helps children understand visibility, surprise, and simple mechanics.



Coloured Window

Transparent polycarbonate panels in bright colors shift children's visual perspective. Looking through them inspires wonder, imaginative play, and shared discoveries.

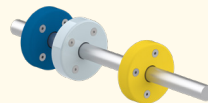

Abacus Play

HDPE spinning panels on a horizontal bar allow kids to explore motion and patterns. The tactile experience supports motor skills and encourages collaborative or parallel play.

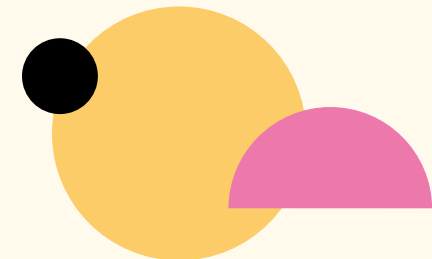

MALINA

3 legs, 2m platform height

Colour options available for:

- Mini Spinning Optical Illusion Insert: ✓
- Mini Shaker Insert: ✓
- Rainbow Insert: ✓
- Wormhole Optical Illusion Insert: ✓
- Tongue Drum Musical Insert: ✓
- Diatonic Cam Chimes Musical Insert: ✓



Mini Spinning Spiral Optical Illusion Insert

Fun and engaging optical illusion which demonstrates how the brain can be tricked.



Mini Shaker Insert

Turn the insert to see and hear hundreds of tiny balls tumble around.

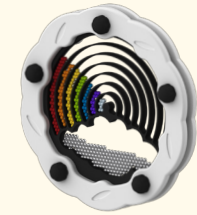

Rainbow Insert

Rotate the drum and watch the coloured balls move around the rainbow.



Wormhole Optical Illusion Insert

Rotate to see swirling patterns as this mind-bending optical illusion comes to life.

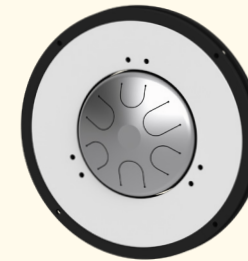

Tongue Drum Musical Insert

Superb oriental sounding stainless steel musical tongue drum played by hand.

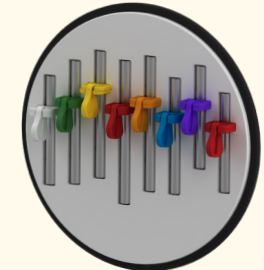

Diatonic Cam Chimes Musical Insert

With 8 tube chimes C-C and custom-designed, free-swivelling cams that replace traditional beaters.



View of panel 1 front and back



View of panel 2

View of panel 3

Objects and data subject to modification.



MALINA

3 legs, 2m platform height

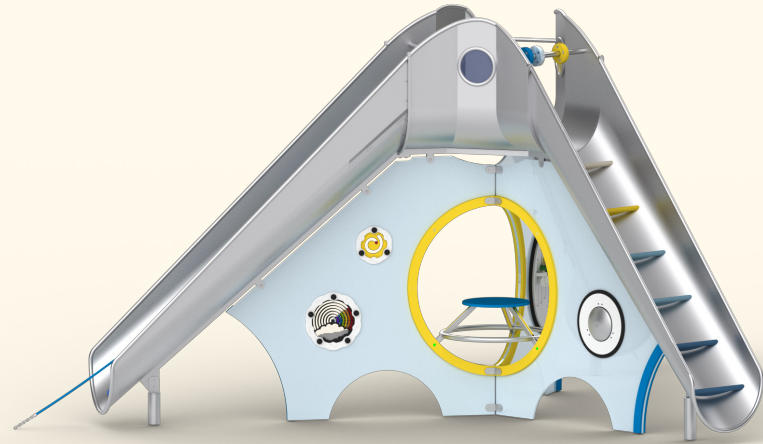
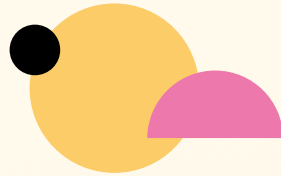
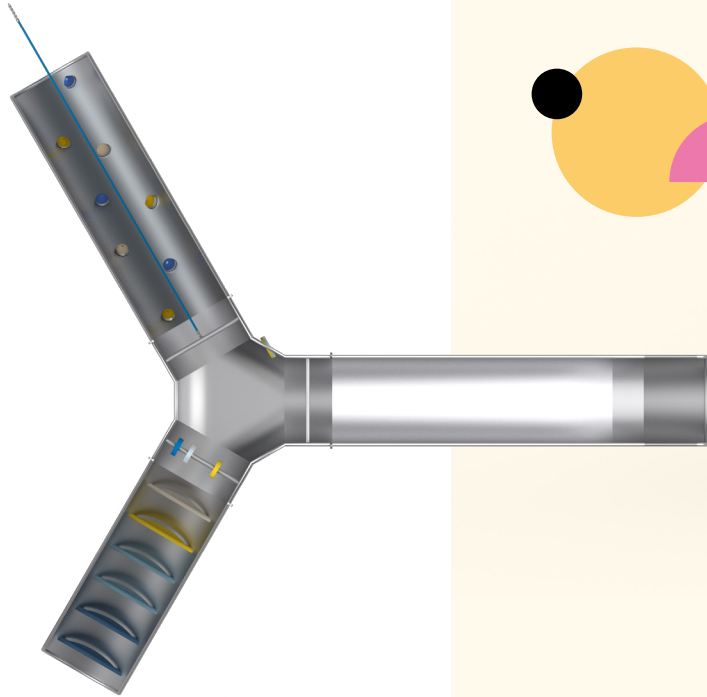

3.00m

2.00m

1.00m

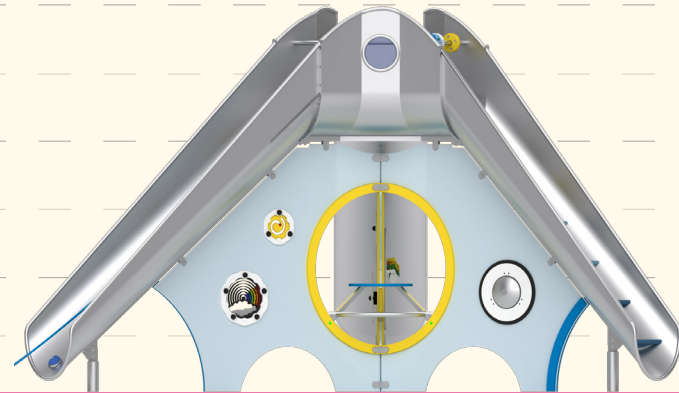
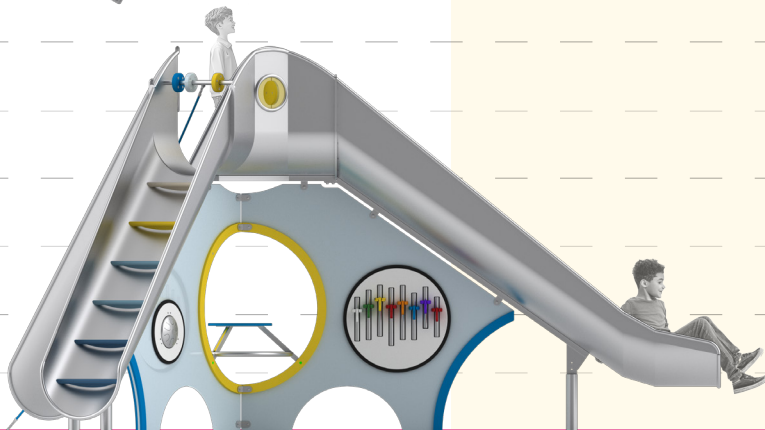

MALINA

3 legs, 2m platform height

Installation information:

Safety zone surfacing area: 8.5m x 9.1m

Concrete volume: 0,68 m³

Footing depth: 80cm/50cm

Shipment weight: 700 kg

Shipment box size: 6x2,2x1,3m

Lead time 6 weeks

Warranty stainless steel parts 36 months

Warranty other parts 24 months

Anchoring options:

-Surface mount Installation -10cm

-Inground Installation -40cm

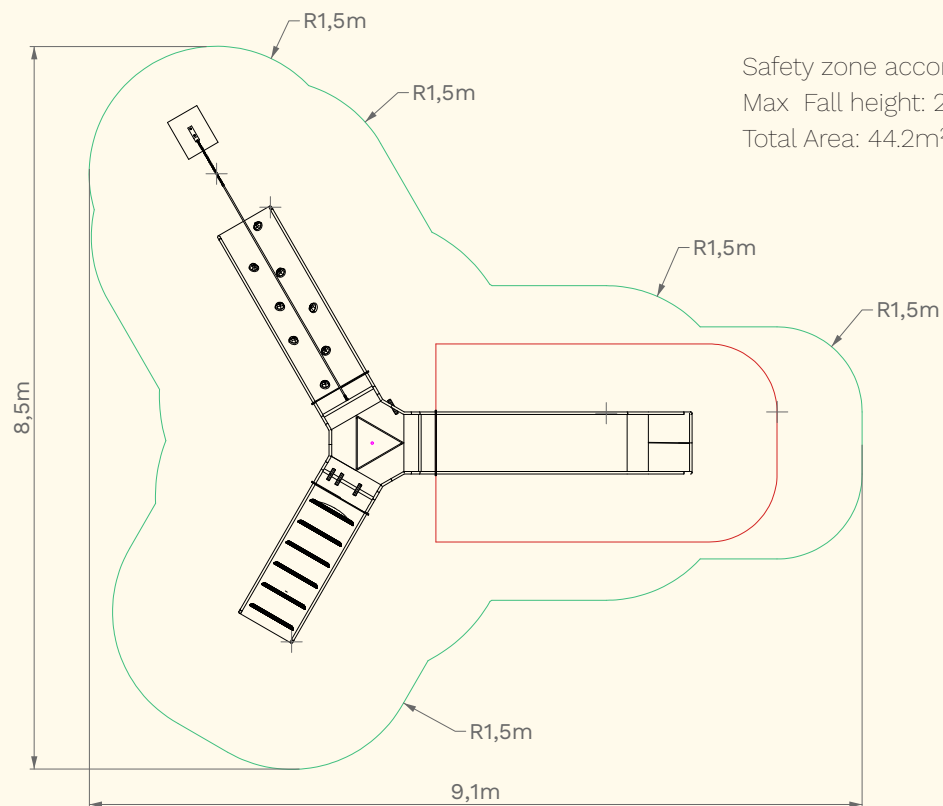

Safety zone according to EN 1176
Max Fall height: 2.00m
Total Area: 44.2m²

Anchoring options:

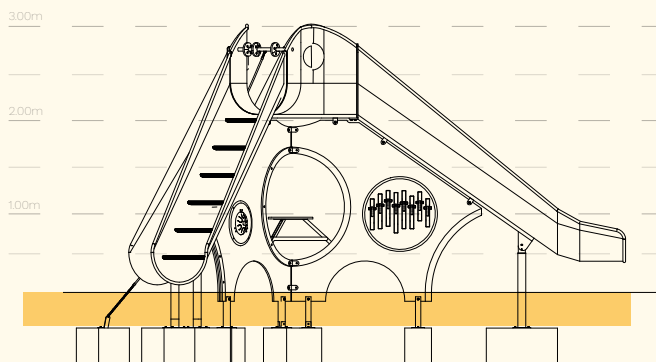

Inground Installation -40cm

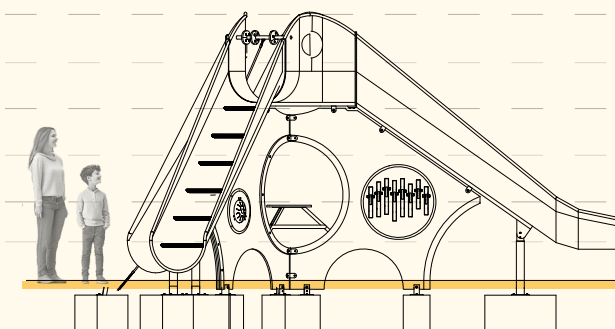

Surface mount Installation -10cm



BERRY

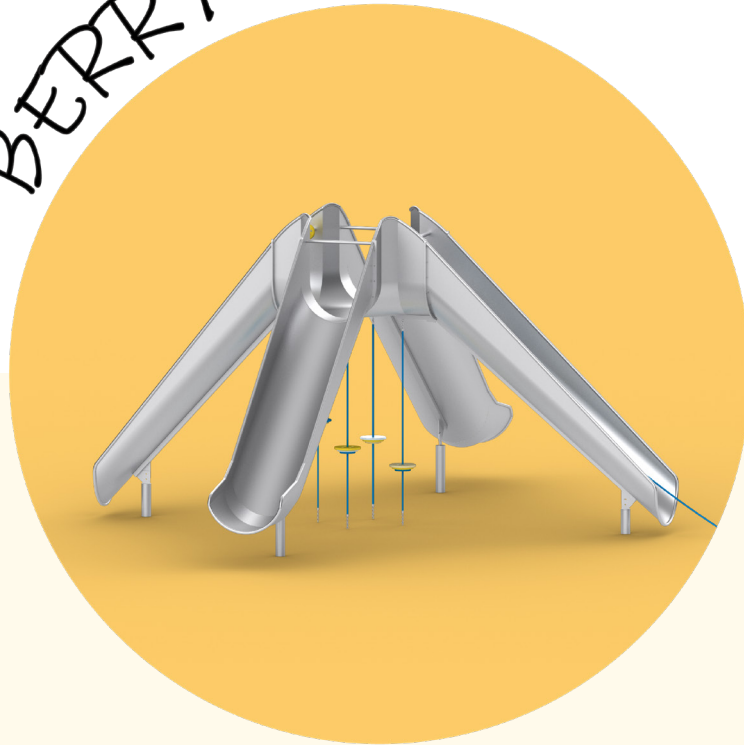

BERRY

4 legs, 2m platform height

BERRY doubles the excitement with two slides in one. Two climbing routes lead to the central platform, offering endless ways to play. Whether racing down or exploring every angle of the structure, kids will find something new with every turn.



BERRY

4 legs, 2m platform height

Highlights:

- Dual Slides
- Climbing Rope & Grips
- Windows & Rotating Plates
- Abacus Plates
- Set of Liana Ropes with Discs

Product Information:

Dimension L x W x H 7.5m x 5.5m x 3m

Age group: 3-99 years

Max falling height: 2.00m

Play activities:

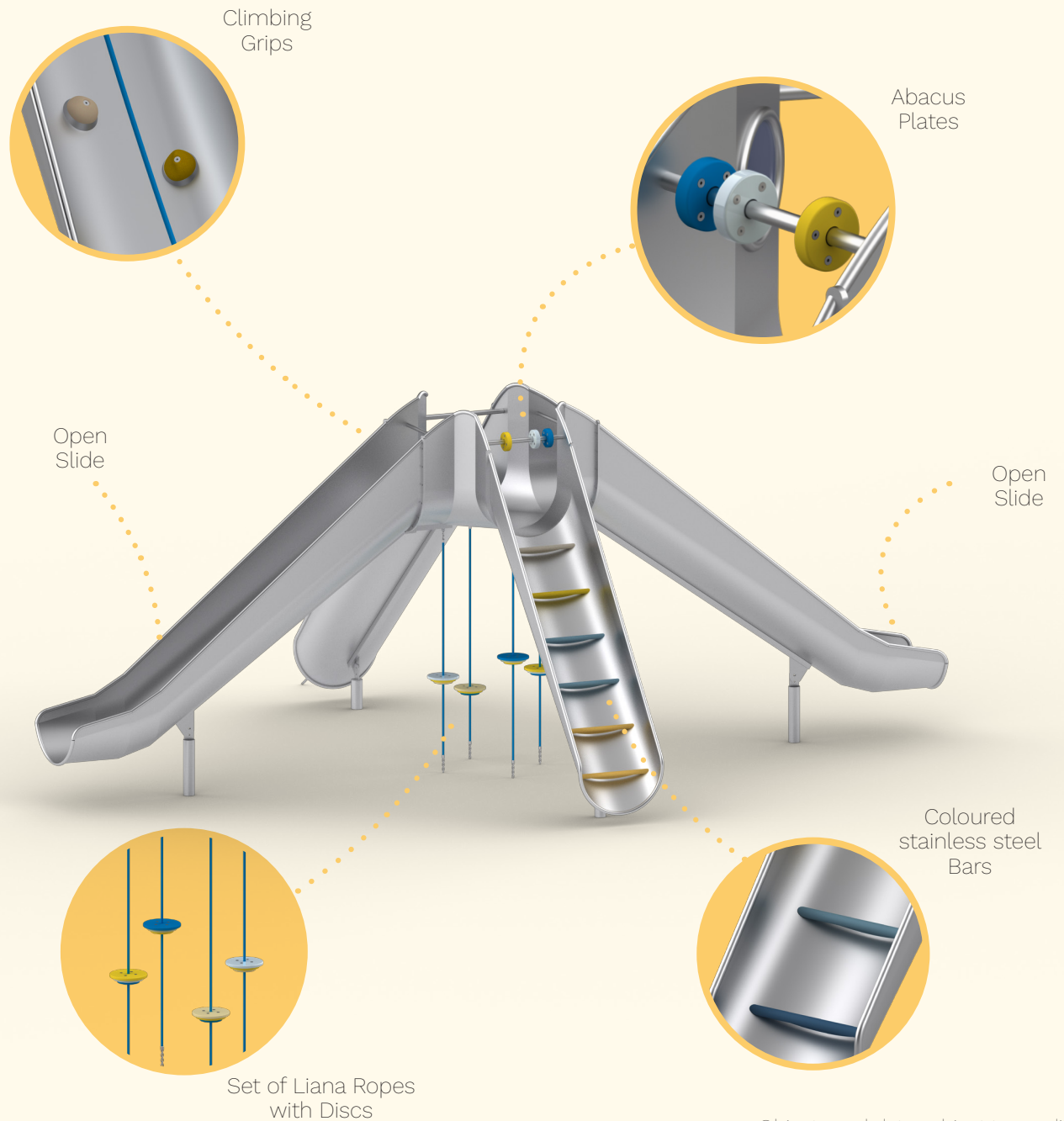

Objects and data subject to modification.



BERRY

4 legs, 2m platform height

Colour options available for:

- Main Slide Structure: ✓
- Climbing Grips: ✓
- Abacus Plates: ✓
- Liana rope set: ✓

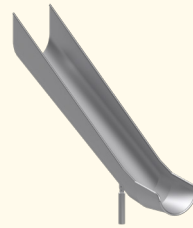

2x Open Slides

Two stainless steel slides starting from 2 m high offers an exciting descent that builds balance, spatial awareness, and core strength. Kids can race down using both slides.

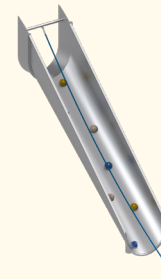

Access Route with Grips & Rope

Equipped with climbing grips and reinforced rope, this access route develops strength, coordination, and problem-solving. Kids learn to navigate vertical movement while taking turns and supporting one another.

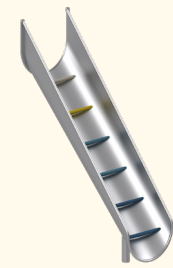

Access Route with Steel Bars

Colorful stainless steel bars challenge children's balance, focus, and body control. The open design encourages anticipation and interaction, adding a social element to physical play.

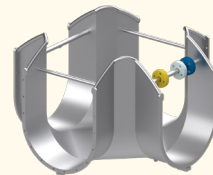

Top Platform

This transition space connects climbing and sliding. Children pause here to observe, plan, and interact with others. It supports social play and decision-making before continuing the activity flow.

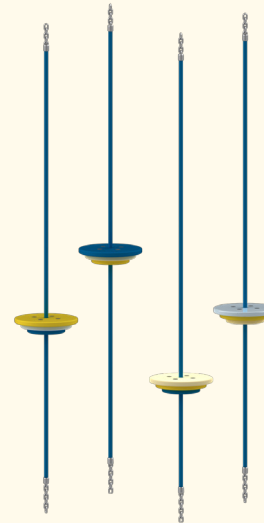

Liana Ropes Set

Three sturdy ropes suspend a round HDPE disc beneath the slide platform, creating a playful spot to sit, sway, or gather with friends. Balancing on the seat develops core strength, coordination, and spatial awareness.

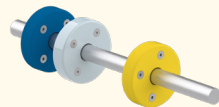

Abacus Play

HDPE spinning panels on a horizontal bar allow kids to explore motion and patterns. The tactile experience supports motor skills and encourages collaborative or parallel play.

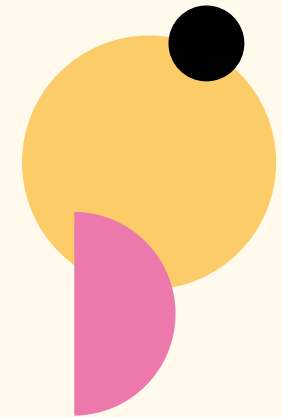

BERRY

4 legs, 2m platform height

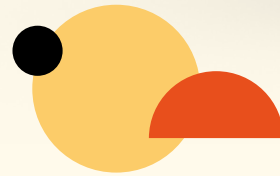
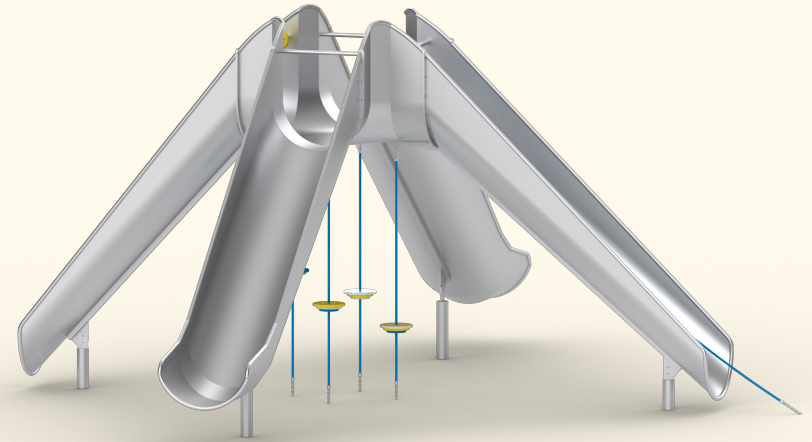
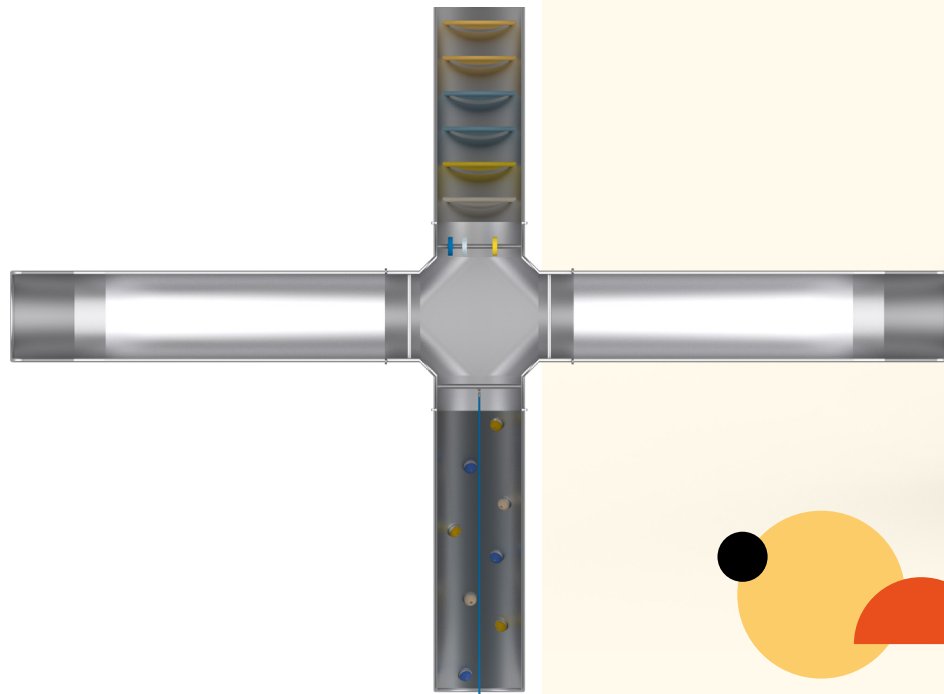

3.00m

2.00m

1.00m

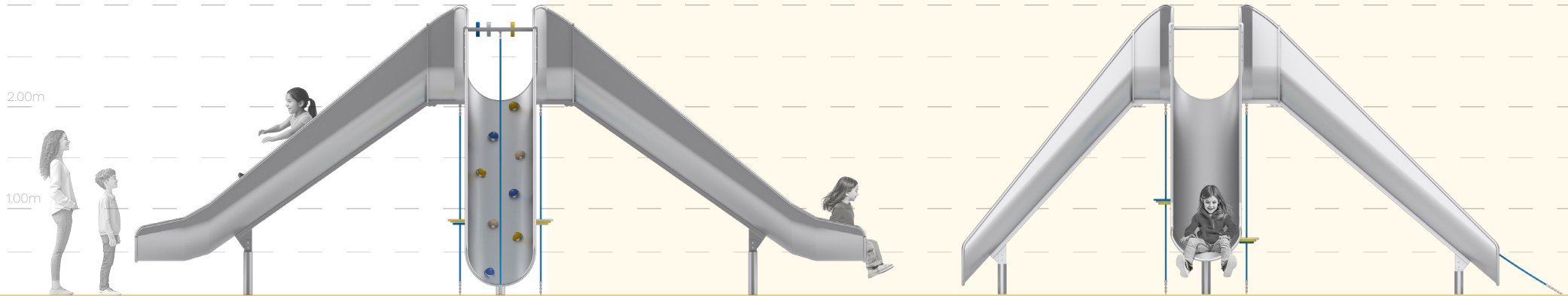

BERRY

4 legs, 2m platform height

Installation information:

Safety zone surfacing area: 11.5m x 9.2m

Concrete volume: 0.73 m³

Footing depth: 80cm/50cm

Shipment weight: 740 kg

Shipment box size: 6x2,2x1,3m

Lead time 6 weeks

Warranty stainless steel parts 36 months

Warranty other parts 24 months

Anchoring options:

-Surface mount Installation -10cm

-Inground Installation -40cm

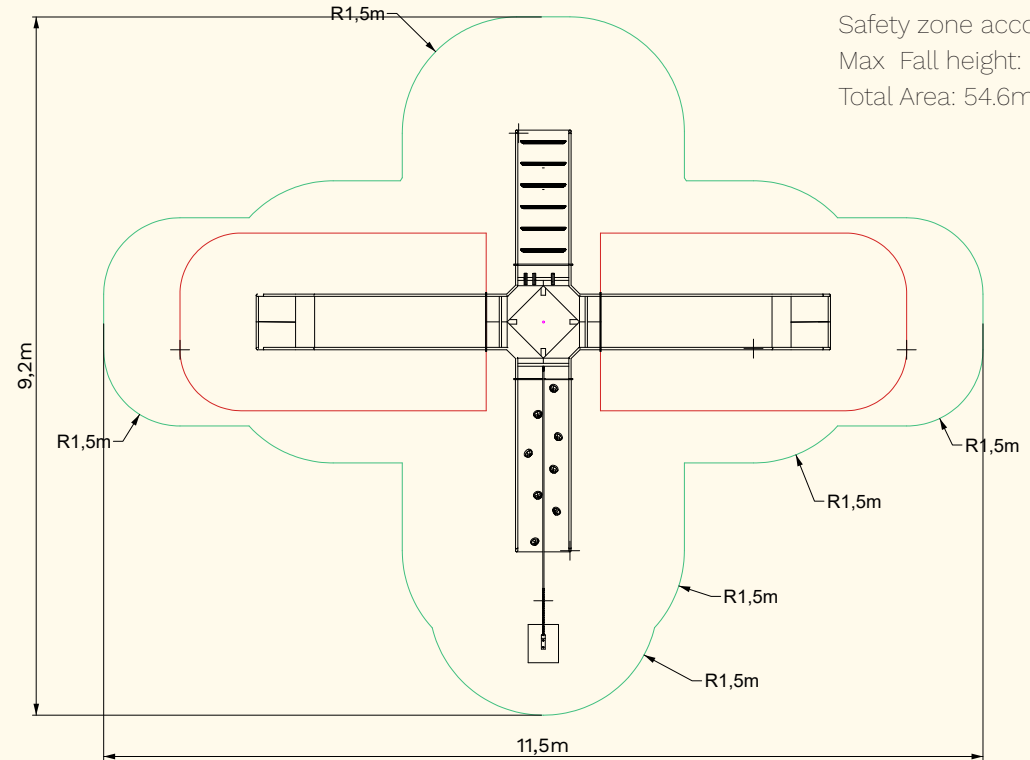

Anchoring options:

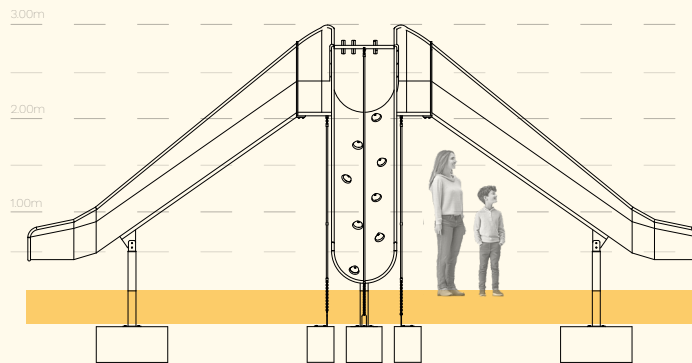

Inground Installation -40cm

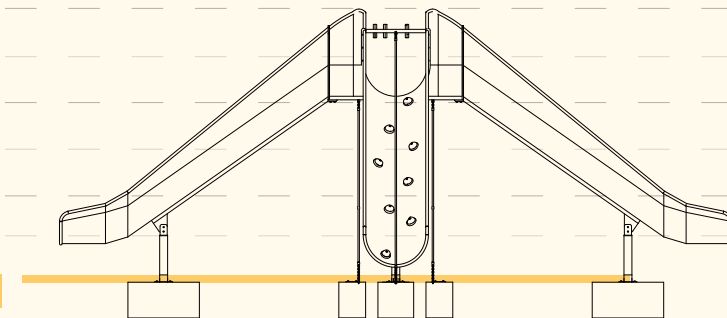

Surface mount Installation -10cm



MIRABELLE

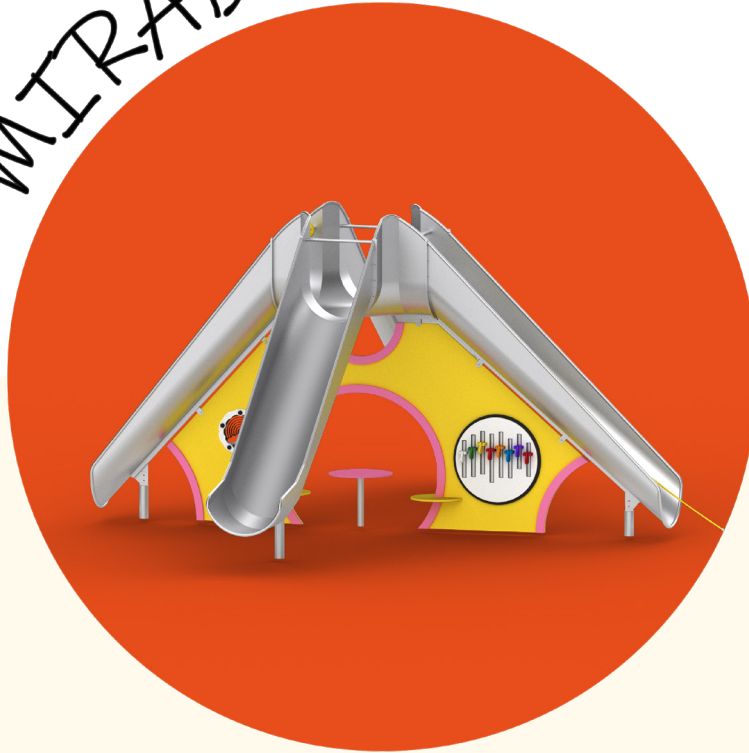

MIRABELLE

4 legs, 2m platform height

MIRABELLE doubles the excitement with two slides in one. It's not just a double slide, it's a playful hub full of surprises. At ground level, sound panels and interactive features invite curious hands. Kids can climb up in a variety of ways, choosing their own path to the top. At the center, a gathering table offers a spot to rest, create, or connect. The whole structure invites kids to explore, imagine, and play, with every step leading to the next fun moment.



HAPPY STRUCTURE - MIRABELLE

4 legs, 2m platform height

Highlights:

- Dual Slides
- Climbing Rope & Grips
- Windows & Rotating Plates
- Optical Illusion Panels
- Gathering Table

Product Information:

Dimension L x W x H 7.5m x 5.5m x 3m

Age group: 3-99 years

Max falling height: 2.00m

Play activities:

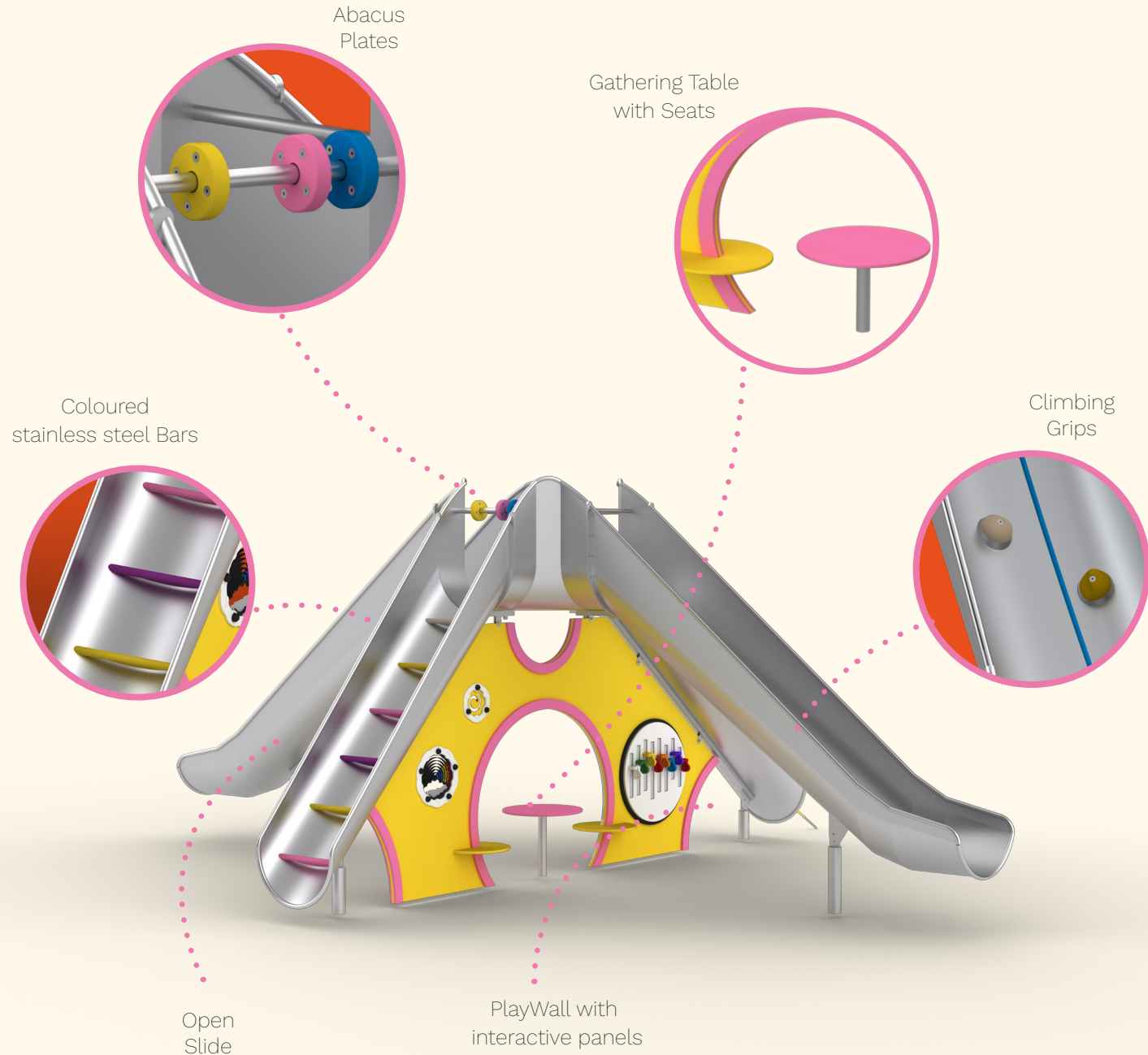
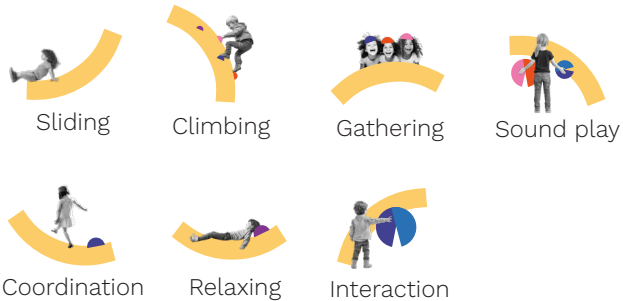

MIRABELLE

4 legs, 2m platform height

Colour options available for:

Main Slide Structure:	✓
Climbing Grips:	✓
Abacus Plates:	✓

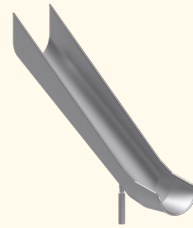

2x Open Slide

Two stainless steel slides starting from 2 m high offers an exciting descent that builds balance, spatial awareness, and core strength. Kids can race down using both slides.

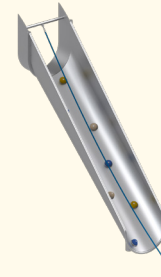

Access Route with Grips & Rope

Equipped with climbing grips and reinforced rope, this access route develops strength, coordination, and problem-solving. Kids learn to navigate vertical movement while taking turns and supporting one another.

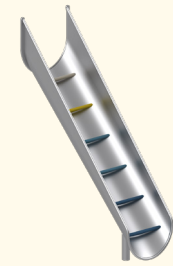

Access Route with Steel Bars

Colorful stainless steel bars challenge children's balance, focus, and body control. The open design encourages anticipation and interaction, adding a social element to physical play.

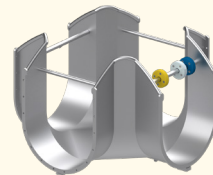

Top Platform

This transition space connects climbing and sliding. Children pause here to observe, plan, and interact with others. It supports social play and decision-making before continuing the activity flow.

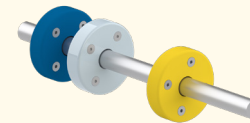

Abacus Play

HDPE spinning panels on a horizontal bar allow kids to explore motion and patterns. The tactile experience supports motor skills and encourages collaborative or parallel play.

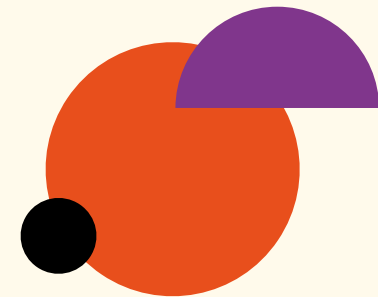

MIRABELLE

4 legs, 2m platform height

Colour options available for:

- Mini Spinning Optical Illusion Insert: ✓
- Mini Shaker Insert: ✓
- Rainbow Insert: ✓
- Wormhole Optical Illusion Insert: ✓
- Diatonic Cam Chimes Musical Insert: ✓



Mini Spinning Spiral Optical Illusion Insert

Fun and engaging optical illusion which demonstrates how the brain can be tricked.



Mini Shaker Insert

Turn the insert to see and hear hundreds of tiny balls tumble around.

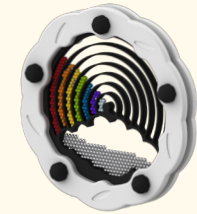

Rainbow Insert

Rotate the drum and watch the coloured balls move around the rainbow.



Wormhole Optical Illusion Insert

Rotate to see swirling patterns as this mind-bending optical illusion comes to life.

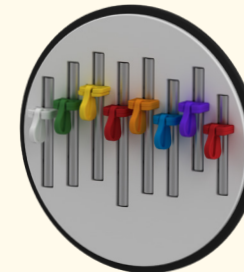

Diatonic Cam Chimes Musical Insert

With 8 tube chimes C-C and custom-designed, free-swivelling cams that replace traditional beaters.

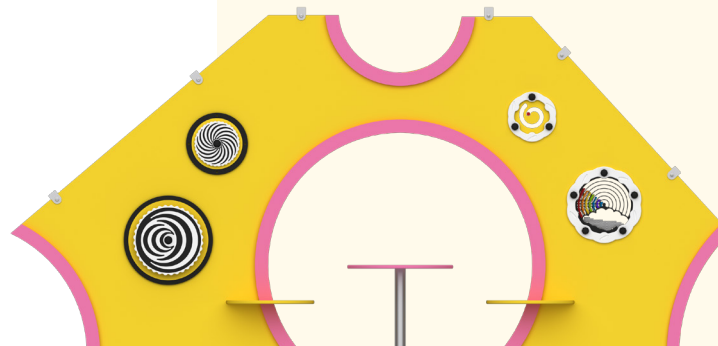

View of panel 1 front

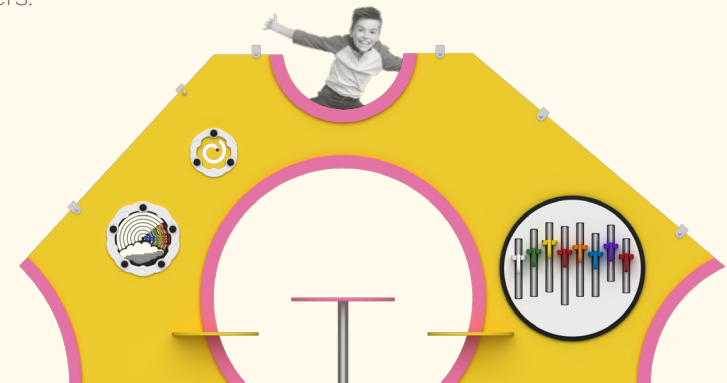

View of panel 1 back



MIRABELLE

4 legs, 2m platform height

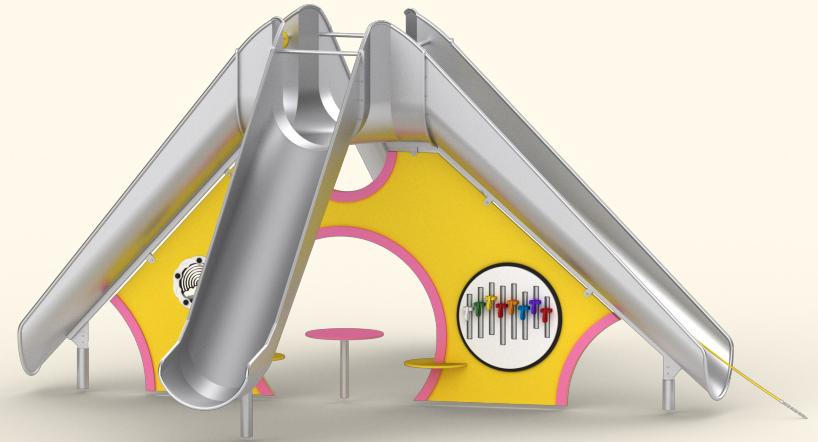
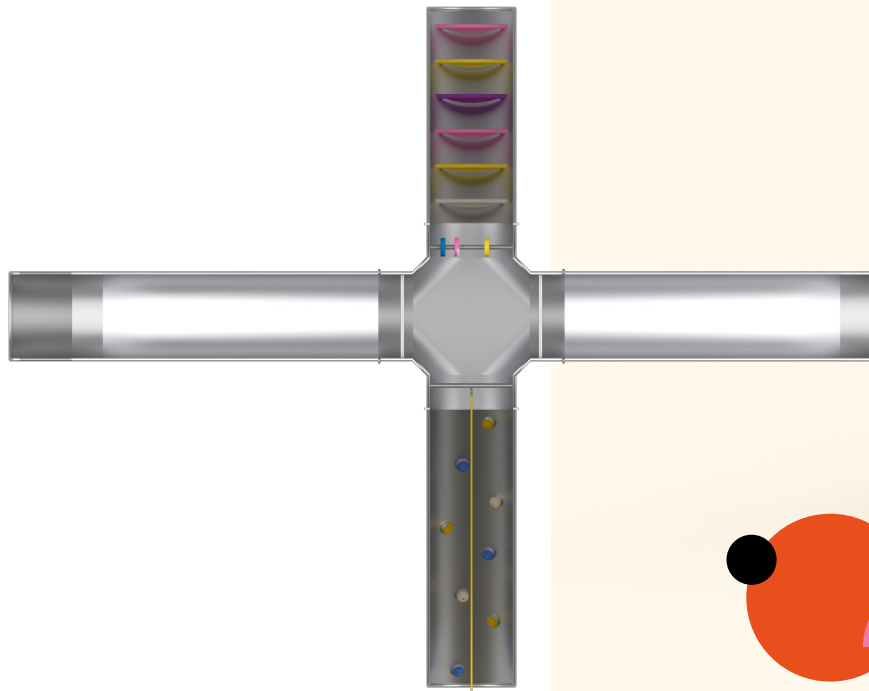

3.00m

2.00m

1.00m

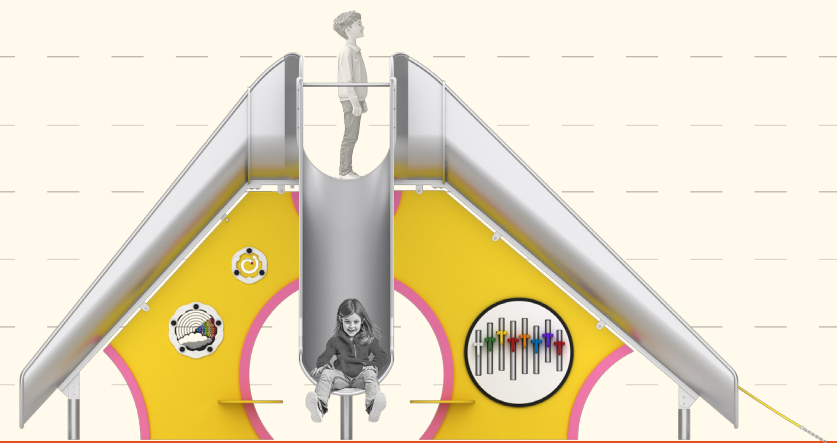
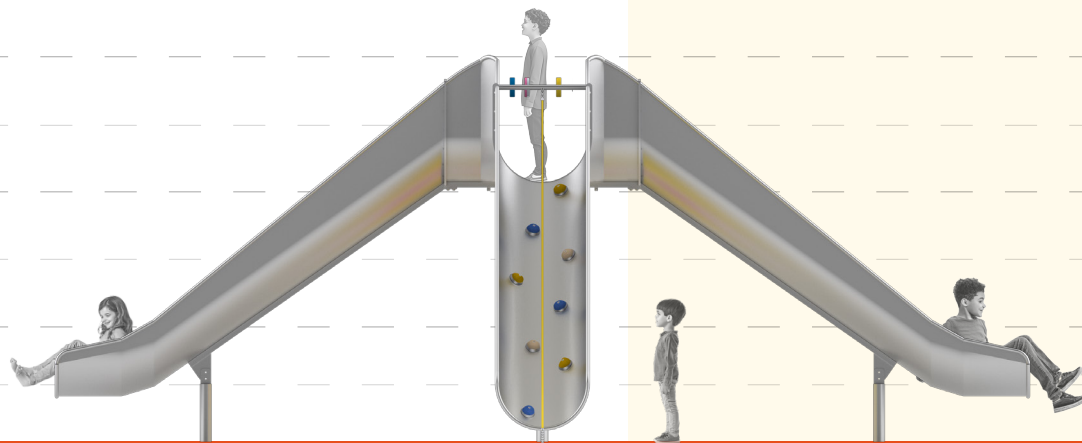

MIRABELLE

4 legs, 2m platform height

Installation information:

Safety zone surfacing area: 11.5m x 9.2m

Concrete volume: 0.7 m³

Footing depth: 50cm/80cm

Shipment weight: 860 kg

Shipment box size: 6x2,2x1,3m

Lead time 6 weeks

Warranty stainless steel parts 36 months

Warranty other parts 24 months

Anchoring options:

-Surface mount Installation -10cm

-Inground Installation -40cm

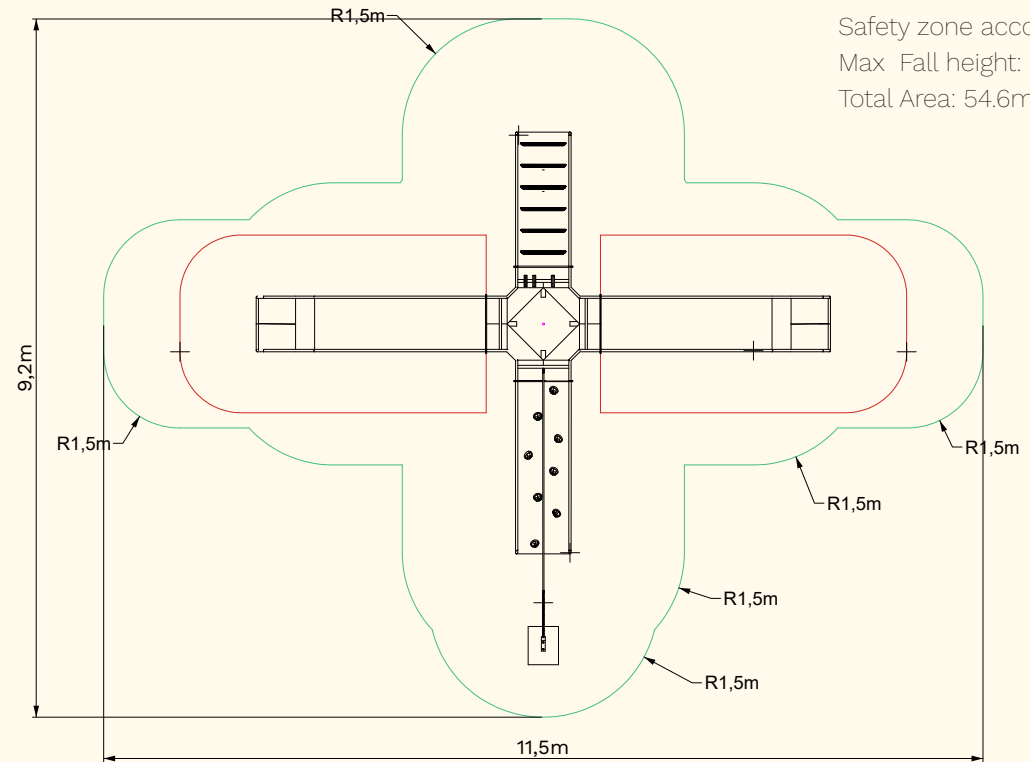

Anchoring options:

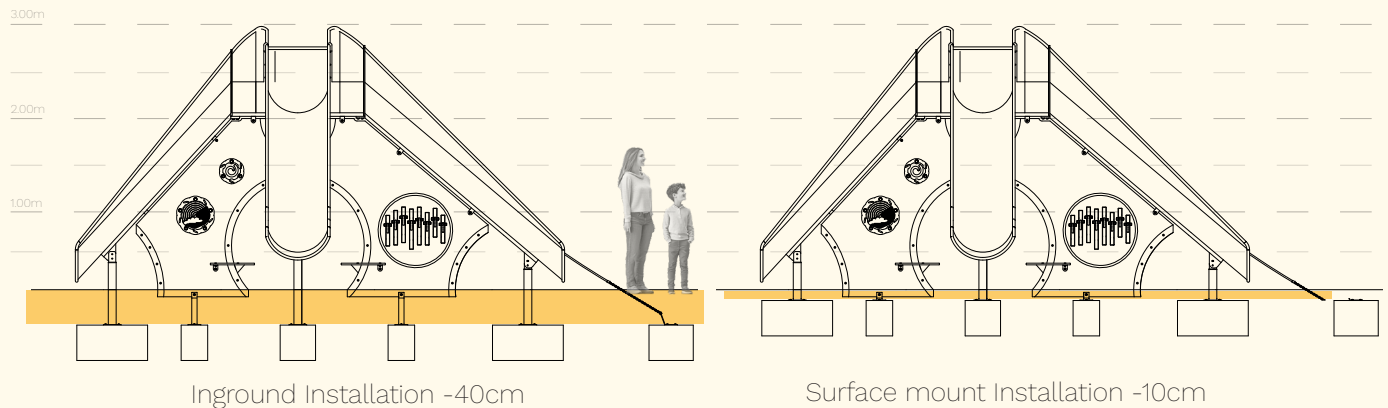



HAPPY STRUCTURES - OVERVIEW

ELMA

Platform height 1.50m

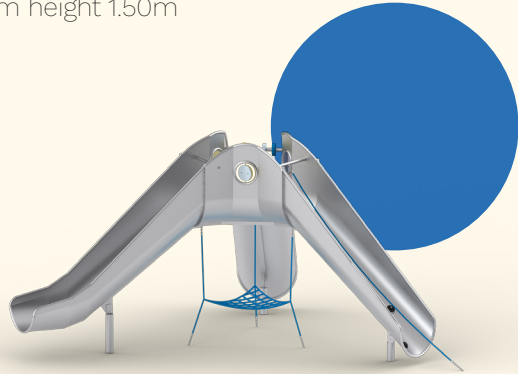

Product number: BA31530

MORA

Platform height 2.00m

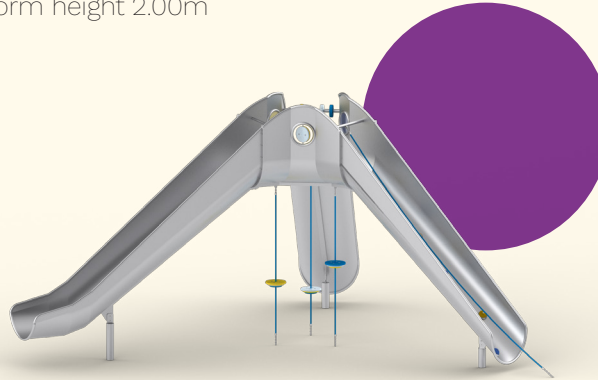

Product number: BA32010

BERRY

Platform height 2.00m

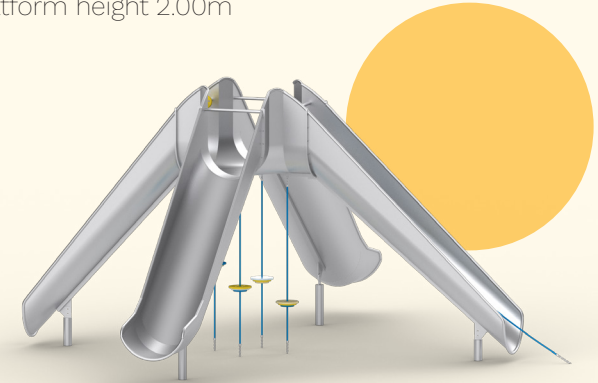

Product number: BA42010

MOMO

Platform height 1.50m

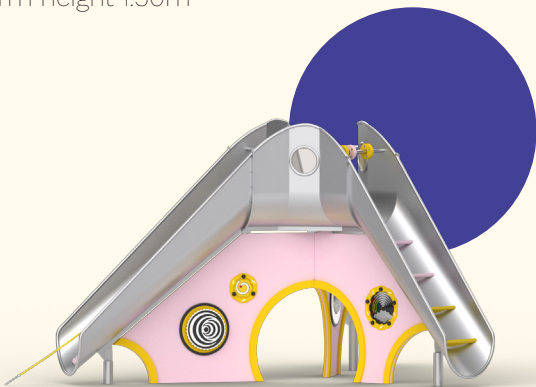

Product number: BA31520

MALINA

Platform height 2.00m

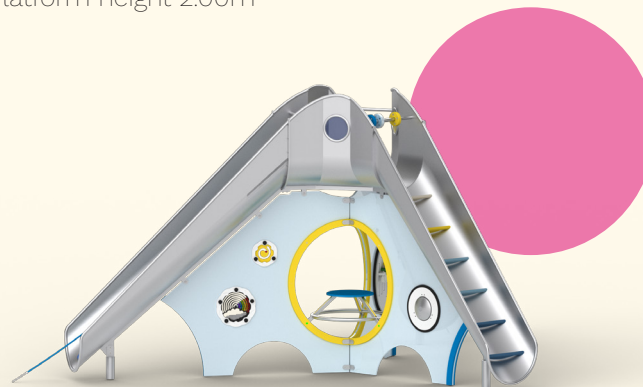

Product number: BA32020

MIRABELLE

Platform height 2.00m



Product number: BA42020



HAPPY STRUCTURES - COLOURS

Slides available in any RAL colour,
examples shown as inspiration.





HAPPY STRUCTURES - TEAM

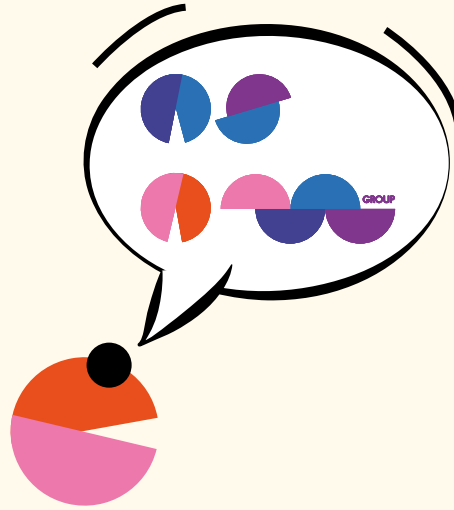

OSOM GROUP specializes in high-quality stainless steel slides, built with precision, durability, and safety in mind. With expert manufacturing and a strong focus on comfort and design, OSOM creates slides that are made to perform in public spaces and built to last.

www.osomgroup.eu



BANANAZ STUDIO creates bold, imaginative play spaces that go beyond the ordinary. With years of experience and a passion for innovation, BANANAZ designs compact, creative structures that turn any space into a playground full of stories, movement, and interaction.

www.bananaz-studio.com

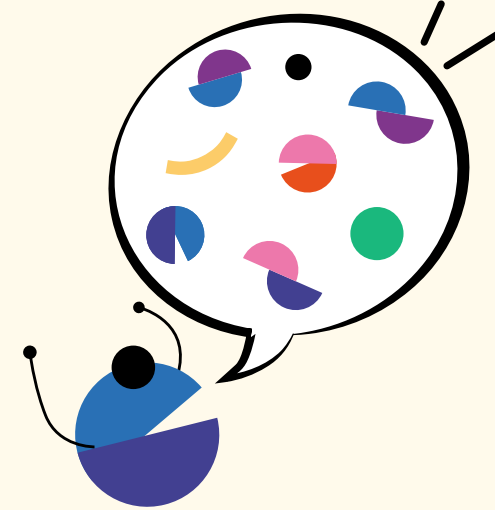

This collaboration brings together BANANAZ's playful design vision and OSOM's engineering excellence. Together, we create slides that do more: climbable, social, sculptural play objects that are made to last and made to spark joy.

www.happystructures.com



www.happystructures.com



contact@osomgroup.eu



info@bananaz-studio.com



HAPPY STRUCTURES

SLIDE
YOUR WAY



Bananaz
STUDIO

